



# **The Effect of Antenna size on DStv Reception in Zimbabwe**

**BY**

**Lazarus Mukarakate**

**REG NUMBER: R123847H**

Submitted in partial fulfillment for the requirement for the degree of Bachelor of

Science Honours Degree in Telecommunication

Department of Applied Physics and Telecommunications

Faculty of Science and Technology at the

Midlands State University

GWERU: ZIMBABWE

JUNE 2015

Supervisor: Mr C Mudzingwa

Co-supervisor: Mr F. Mazunga

## **Abstract**

DStv is the only provider of pay television in Zimbabwe at present with over 70 000 subscribers registered country wide. DStv is the flagship product of Multichoice providing various bouquets offering General Entertainment, Movies, Lifestyle & Culture, Sport, Documentaries, News and Commerce, Children, Music Religion and Consumer channels Multichoice subscribers throughout Africa.[3]. In order to receive the transmitted signal at the recommended level, Multichoice insists subscribers use the recommended correct antenna size. The recommended antenna size for Zimbabwe is 90cm. Despite this a lot of subscribers are using antennas much smaller than this. This project set out to investigate and come out with a better and informed view regarding this issue. Included in this report are the detailed results showing the comparison between a 60cm antenna and 90cm antenna. A detailed analysis on the level of power received the carrier-to-noise ratio and BER data will show one needs a minimum antenna size of 90cm to be assured of getting the best signal.

This research will open up the debate on this hot topic as far as Multichoice is concerned and maybe come up with a final decision regarding the issue.

## **DECLARATION**

I, LAZARUS MUKARAKATE, hereby declare that I am the sole author of this thesis. I authorize the Midlands State University to lend this thesis to other institutions or individuals for the purpose of scholarly research.

Signature..... Date .....

## **APPROVAL**

This dissertation/thesis entitled **COMPARISON BETWEEN 60CM AND 90CM ANTENNA ON RCEPTION OF DStv TELEVISION SIGNAL IN ZIMBABWE** by Lazarus Mukarakate meets the regulations governing the award of the degree **BSc TELECOMMUNICATIONS HONOURS** of the Midlands State University, and is approved for its contribution to knowledge and literal presentation.

Supervisor .....

Date .....

## **Acknowledgements**

My heartfelt appreciation goes out to all those who put their time and resources to this project without whom this project might not have been completed. I would like to extend my sincere gratitude to all my classmate and friends for their encouragement and support throughout my whole period at the university. Special thanks goes to My wife, Daisy Mukarakate for indeed she was the pillar of my strength who's help made it possible for me to complete this degree and Martin Ungerer, the Technical and After Sales Manager for Multichoice Africa for technical and material support and advice during the duration of this project. My gratitude also goes to the staff of Multichoice Zimbabwe with special mention of Mr Dave Emberton and 'Mukoma George' as he is affectionately known, my entire family for believing in me, not forgetting Alec Mbiro and Tamuka Chiyangwa who were my assistants during the testing of this project. I would also like to extend sincere thanks to the Faculty of Science and Technology in general and the Department of Applied Physics and Telecommunications members of staff for their support throughout the formative years at this university.

Lastly, my special thanks go to Mr C. Mudzingwa and Mr F. Mazunga my supervisors. May they be richly blessed by the Almighty.

# TABLE OF CONTENTS

Abstract.....	i
DECLARATION .....	ii
APPROVAL .....	iii
Acknowledgements.....	iv
CHAPTER 1 .....	1
1.1 Introduction .....	1
1.2 Problem Statement.....	1
1.3 Aim .....	1
1.4 Objective.....	2
1.5 Test Set-up.....	2
CHAPTER 2 .....	3
LITRETURE REVIEW .....	3
2.0 Introduction.....	3
2.1 Resistance and Impedance .....	4
2.1.1 Ohms Law.....	4
2.1.2 The Difference between Resistance and Impedance .....	5
2.2 The Decibel.....	5
2.2.1 Why do we use the dB? .....	5
2.2.2 The Voltage dB .....	6
2.2.3 The Power dB .....	7
2.2.4 What the Meter Shows (dB readings) .....	8
2.3 Filters.....	9
2.3.1 What are Filters? .....	9
2.3.2 The Low Pass Filter .....	9
2.3.3 The High Pass Filter.....	9
2.3.4 The Notch Filter .....	10
2.3.5 The Band Pass Filter .....	10
2.3.6 Attenuators.....	11
2.3.7 The Slope Attenuator .....	11

2.3.8	Combiners .....	11
2.4	Mismatches.....	12
2.4.1	Characteristic Impedance .....	12
2.4.2	What are Mismatches.....	14
2.4.3	VSWR.....	15
2.4.4	The Reflection Co-efficient .....	16
2.4.5	The Return Loss .....	17
2.5	Distortion .....	17
2.5.1	Intermodulation.....	17
2.5.2	Cross modulation .....	18
2.5.3	Sync Pulse Compression.....	20
2.5.4	Adjacent Channel Interference.....	20
2.6	Noise.....	22
2.6.1	What Is Noise?.....	22
2.6.2	Bandwidth and Noise.....	23
2.6.3	Carrier to Noise.....	24
2.7	Frequency and Wavelength .....	26
2.7.1	The Speed of Light.....	26
2.7.2	Calculating Wavelength.....	26
2.7.3	The Phasing of Signals.....	27
2.8	Television Standards .....	29
2.8.1	PAL.....	29
2.8.2	B/G or I.....	30
2.8.3	SECAM.....	32
2.9	Terrestrial Transmissions.....	35
2.9.1	Free Space Losses .....	35
2.9.2	Signal Strength and Field Strength .....	36
2.9.3	Digital Carrier Power.....	37
2.9.4	Reflections .....	39
2.9.5	Diffraction.....	40
2.10	Satellite Transmission.....	42
	Free Space Losses.....	42

2.10.5.6 The Satellite Transmission Path .....	48
2.10.5.7 What Level of Signal do we receive?.....	48
2.11.1 Amplitude Modulation.....	49
CHAPTER 3 .....	57
TESTING METHODOLOGY .....	57
3.3 Test Preparation.....	58
3.4 Test Setup.....	59
3.5 Testing Process.....	60
3.6 Documentation of Test Results .....	61
3.7 Conclusion.....	61
CHAPTER 4 .....	62
DATA PRESENTATION AND ANALYSIS .....	62
4.1 Introduction.....	62
4.2 Results .....	62
4.2.1 Results for 60cm antenna under clear weather.....	62
4.2.2 Results of measurements using 90cm antenna under clear weather .....	63
4.2.3 Results of tests taken for the 60cm antenna under rainy conditions.....	63
4.2.5 Results on TV display for 60cm and 90cm under light rain conditions.....	64
4.3 Data Presentation.....	64
4.4 Data Analyses .....	65
4.5 Findings .....	65
CHAPTER 5 .....	66
CONCLUSIONS AND RECOMMENDATIONS.....	66
5.1 Summary and conclusion .....	66
5.2 Recommendations .....	67
REFERENCES.....	69



# CHAPTER 1

## 1.1 Introduction

Today television broadcasting is at the crossroads of analogue and digital transmission through space and via broadband cable. Satellite television started transmitting in the digital domain since 1995. We are now reached the frontier of the merging of all the different technologies involving television, radio and data which will now change the way we have traditionally viewed television. If we think about digital television signal as computer signals at very wide bandwidth using radio frequencies as carriers, we can draw the conclusion that if all the signals are in the digital domain they can easily be merged.

## 1.2 Problem Statement

Multichoice launched its Digital Satellite television (DStv) broadcasting in Africa in 2000. Since then many developments have occurred in this field. Because of the nature of transmission of the satellite in relation to earth, certain specifications are drawn up in order for one to receive an acceptable signal one of which is the receiving antenna size. Different sizes of antenna are recommended for each region in Africa. In Zimbabwe the recommended minimum size is 90cm diameter. Notwithstanding that, a lot of installations are done using reception antennas that are 60cm in diameter and below.

The challenge is to come up with a recommendation that will be acceptable to both the Multichoice and its subscribers. Multichoice strongly recommends an antenna size of 90cm or above and yet there seems to be more 60cm size antennas in use around Zimbabwe.

## 1.3 Aim

The aim of the project is to establish the correct size of antenna to use for DStv reception for Zimbabwe so that subscribers can get the best picture quality and interactive services. The research method will involve the use of a signal generator, signal analyzer, signal

meter, DVMS test receiver, control PC RF source, mixer, amplifier and attenuator, 60cm antenna, 90cm antenna, and DStv decoders.

## 1.4 Objective

This area of study is important as it seeks to guide people on the correct equipment to buy in order to receive a perfect DStv signal in their homes, work places, restaurants, hotels, schools, colleges, and clubs. It seeks to give people value for money from their pay TV subscriptions as it improves the quality of viewing as well as down time.

## 1.5 Test Set-up

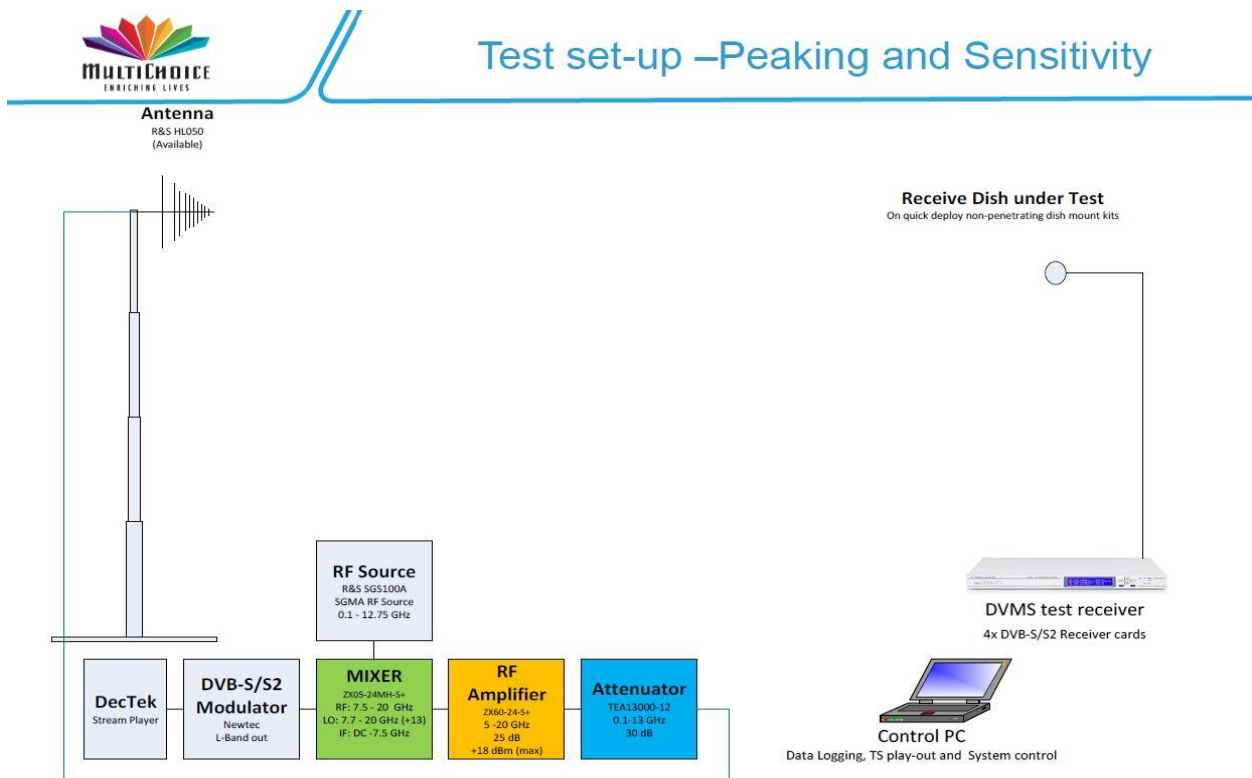

# CHAPTER 2

## LITRETURE REVIEW

### 2.0 Introduction

Today television stands at the crossroads of analogue and digital television transmission terrestrially and via broadband cable. Satellite television began transmitting in the digital domain since 1995. We have now reached the final frontier of the merging of all the different technologies involving television, radio and data which will now change the way we have traditionally viewed television.

If one thinks of the digital television signals as computer signals at very wide bandwidth using radio frequencies as carriers, one can draw the conclusion that if all the signals are in the digital domain they can now easily be merged.

In this Chapter we will concentrate on all the aspects that will allow us to design and implement quality signals that will allow us to provide excellent television and radio systems for signal distribution in homes, hotels, apartment blocks and security villages.

Included in this report will be some calculations, but these are for demonstration purposes only. The aim of these calculations is to make the reader aware of the parameters that can affect signal distribution and aid in the design of a system. Designing and/or adding to distribution systems is no “rocket science” and it should be possible to implement quality systems if all the rules and procedures are followed. One should be able to read and analyze equipment specifications after reading this report.

This chapter will look at the factors that affect quality signal reception and distribution.

## 2.1 Resistance and Impedance

### 2.1.1 Ohms Law

The basis of electrical calculations is based on a simple triangle used to demonstrate Ohm's law.

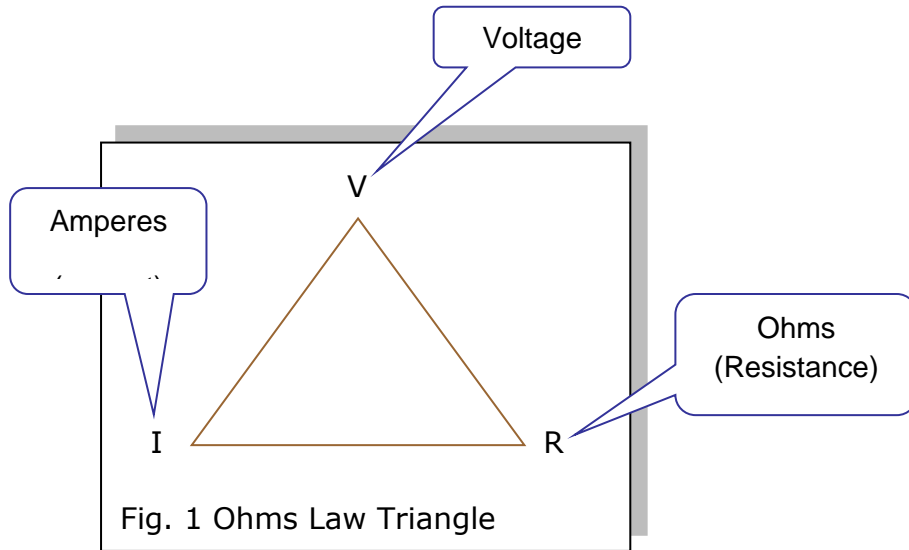

**Figure 2.1 Ohm's Law Triangle**

If we now analyze the above triangle we will notice that there are three values on the triangle. It can easily be interpreted to find a value we should have two of the values. Every time we a current (amps) flowing through a resistance a voltage is measured across that resistance and likewise when a voltage is applied across a resistance, amps will flow.

If we take a look at the chart below we will notice how easy it is to do these calculations.

	$I$	$=$	$V/R$
	$R$	$=$	$V/I$
	$V$	$=$	$I \times R$
But WATTS	$= V \times I$	so we can also use this triangle as follows;	
$W$	$= V \times (V/R)$	$=$	$V^2/R$
$W$	$= (I \times R) \times I$	$=$	$I^2 R$

### 2.1.2 The Difference between Resistance and Impedance

When the resistance value is not affected by different frequencies we will have a linear relationship between voltage and amperage we refer to this value as resistance.

However, when dealing with cable systems we will find that we refer to these values as impedance. The reason for all this is that the values can be frequency dependent as the circuits contain two components, namely inductors and capacitors that change the “resistance” according to frequency

## 2.2 The Decibel

### 2.2.1 Why do we use the dB?

A decibel is used as a convenient way of calculating signal or power gain and loss as this only requires the use of adding and subtracting in the planning of systems. We not only use the decibel in television technology, but is used in all types of electronic signal technologies. We are discussing this for the reason that the decibel will be repeatedly referred to during this project as nearly all specifications are listed in decibels.

**N.B** *The decibel is regarded as a ratio between two values. Even where the decibel is used to denote an absolute value this is referred to a standard value.*

Firstly we take a look at the basic differences between a linear and a logarithmic relationship. The graphs below, fig 2.2, tries to explain the basic differences between linear and logarithmic.

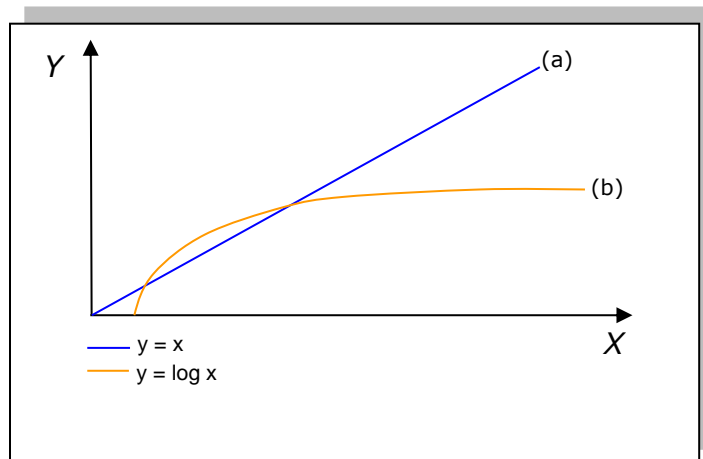

Fig 2.2 Linear vs. Log Graphs

If we refer to the graph of figure 2.2(a) we notice that the line is straight, but the graph in figure 2(b) is curved. This is known as a logarithmic curve.

A chart will show us the value differences.

Table 2.1

<u>X</u>	<u>Y=X</u>	<u>Y=log X</u>
1	1	0.00
2	2	0.30
3	3	0.48
4	4	0.60
5	5	0.69
6	6	0.78
7	7	0.85
8	8	0.90
9	9	0.95
10	10	1.00

The basic understanding of the relationship between linear and logarithmic is that the linear relation is a straight line, but the logarithmic relationship is not as we will see in the pages to follow.

Table 2.2

<u>STANDARD LOGARITHMIC VALUES</u>			
0 dBuV	=	1uV	= 1 microvolt
0 dBmV	=	1mV	= 1 millivolt
0dBV	=	1V	= 1 volt
0dBm	=	1mW	= 1 milliwatt
0dBW	=	1W	= 1 watt

### 2.2.2 The Voltage dB

Each time we refer to this value we use the calculation of;

$$20*\log(V_{out}/V_{in}).$$

As mentioned earlier the dB is used as a comparison between two values so below we will show two examples;

#### EXAMPLE 1;

The input voltage to a device is measured as 5 Volts and the output voltage is 13 Volts. We can calculate the dB ratio as follows;

$$20*\log(13/5) = 20*\log(2.6) = \underline{\mathbf{8.3\ dB}}$$

#### EXAMPLE 2;

The input voltage to a device is measured at 13 Volts and the output voltage is 5 Volts. We can calculate the dB ratio as follows;

$$20*\log(5/13) = 20*\log(0.38) = \underline{\mathbf{-8.4\ dB}}$$

*(N.B. Notice example 2 shows a negative value which means that the output value is smaller than the input value.)*

But, this voltage, cannot exist in thin air and is only of use when it is applied across a load or comes from a source which means that there will be current generated as both the source and load have a resistance or impedance. We therefore have to consider power which is a different logarithmic calculation.

### **2.2.3 The Power dB**

When we refer to this value we use;

$$10*\log(P_{out}/P_{in}).$$

If we use the same values as in the above examples we have the following;

#### EXAMPLE 3;

The wattage at the input of a device is 5 watt and the power at the output of this device is 13 watt we have;

$$10*\log(13/5) = 10*\log(2.6) = \underline{\mathbf{4.15\ dB}}$$

EXAMPLE 4;

The wattage at the input of a device is 13 watt and the power at the output of this device is 5 watt we have;

$$10*\log(5/13) = 10*\log(0.38) = \underline{-4.2 \text{ dB}}$$

Notice that the decibel values obtained when doing the power measurements are half those obtained when doing voltage measurements.

Table 2.3

<u>LINEAR VALUE</u>	<u>POWER dB</u>	<u>VOLTAGE dB</u>
100x	+20	+40
10x	+10	+20
8x	+9	+18
4x	+6	+12
2x	+3	+6
1x	+0	+0
½	-3	-6
¼	-6	-12
1/8	-9	-18
1/10	-10	-20
1/100	-20	-40

### 2.2.4 What the Meter Shows (dB readings)

We have discussed voltage decibels and power decibels, but this might get confusing when deciding how to interpret the readings on a field strength meter. Earlier on it was mentioned that the voltages are usually measured across a load or source which has impedance. The field strength meter input socket has impedance known as the input impedance. The impedance of a television field strength meter is 75 Ohm.

This means that we should interpret the dB readings on the field strength meter as power ratios even if the readings are in dBuV.

*(Most meters can be set to read dBm, but as these are always negative quantities it is easier to use dBuV. Most of the products used in distribution systems have their specifications in dBuV.)*

NOTE: The dBuV reading varies according to the impedance that the voltage is measured across. As a point of interest the value of 0dBm (1mW) will be 108.6 dBuV across a 75 Ohm load and 107 dBuV across a 50 Ohm load.



## 2.3 Filters

### 2.3.1 What are Filters?

Filters are devices that either, allows certain bands of frequencies through, or is used to attenuate a certain band of frequencies. Filters are usually made from passive components, but today we have digital filters that are electronically controlled and have much sharper slopes.

The ideal filter has very steep slopes, but practical filters all have slopes as shown as shown below.

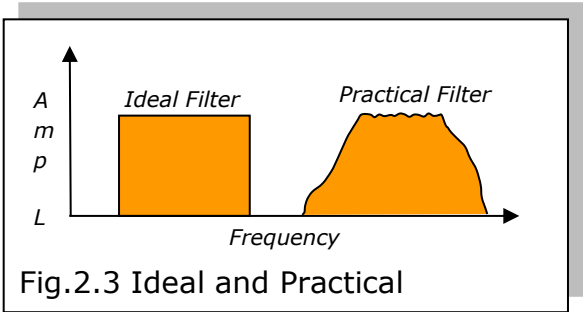

### 2.3.2 The Low Pass Filter

The purpose of the low pass filter is to pass all frequencies below a certain cut-off point and is used where only the lower frequencies are required and the higher frequencies need to be eliminated. See Fig.2.4

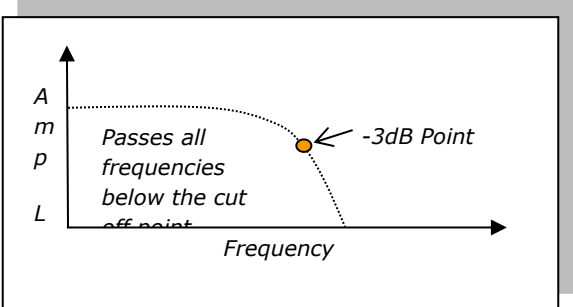
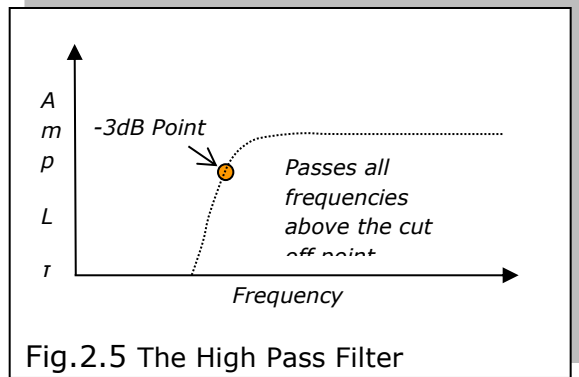

Fig 2.4 The Low Pass Filter

### 2.3.3 The High Pass Filter

This filter passes all frequencies above a certain cut-off point and is used all where only the higher frequencies need to be passed and the lower frequencies need to be eliminated.



### 2.3.4 The Notch Filter

We use this filter when a certain frequency, channel or group of frequencies need to be eliminated. Notch filters are usually used to eliminate frequencies that will cause interferences.

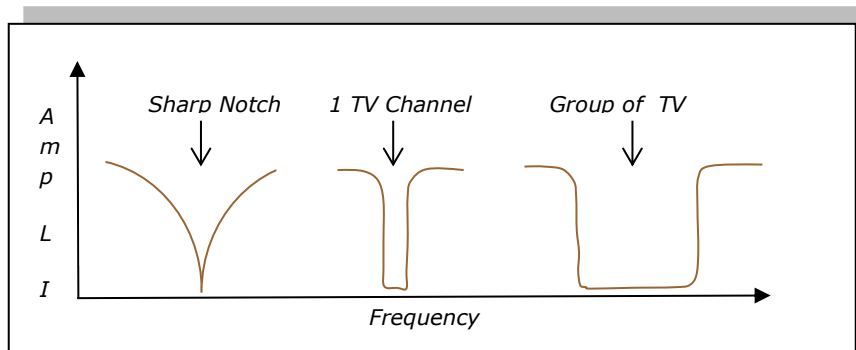

### 2.3.5 The Band Pass Filter

This filter is used to only pass a certain group or even a single frequency. It is used to pass frequencies that will be utilized in the system.

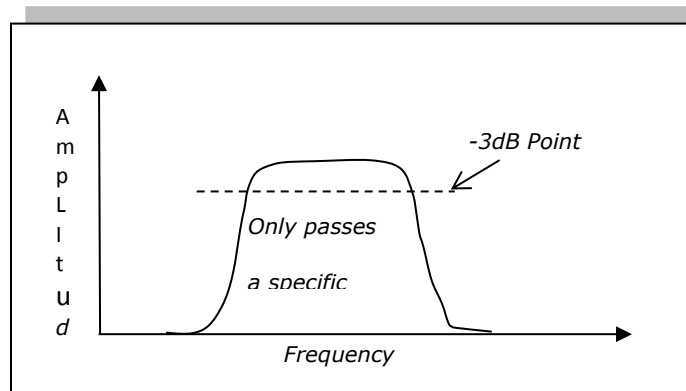

### 2.3.6 Attenuators

Attenuators are devices that reduce (attenuate) all the frequencies by the same amount. They are used when signal levels are too high. These attenuators can have a fixed value or may be variable.

### 2.3.7 The Slope Attenuator

These are special devices that provide more attenuation at the lower frequencies than at the higher frequencies. As we will learn later in the sections ahead higher frequencies have a higher transmission loss in coaxial cable than the lower frequencies resulting in an imbalance at the end of the cable. They are usually used before amplifiers to ensure that all the frequencies are at the same level.

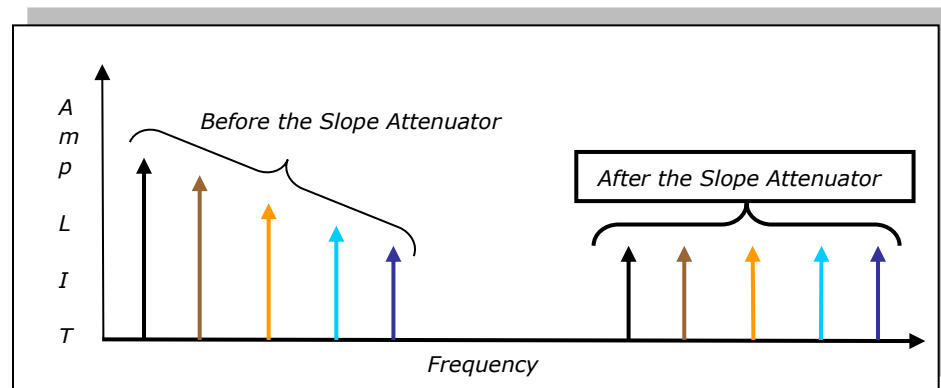

Fig 2.8 The Slope Attenuator

### 2.3.8 Combiners

These devices are used to combine different groups of frequencies. The most common ones are the terrestrial antenna combiners that combine the VHF and UHF terrestrial antenna signals.

Another combiner that is common is one that combines satellite and terrestrial signals.

They are used to reduce the amount of cable or sometimes where the conduit is too small to allow for a number of cables.

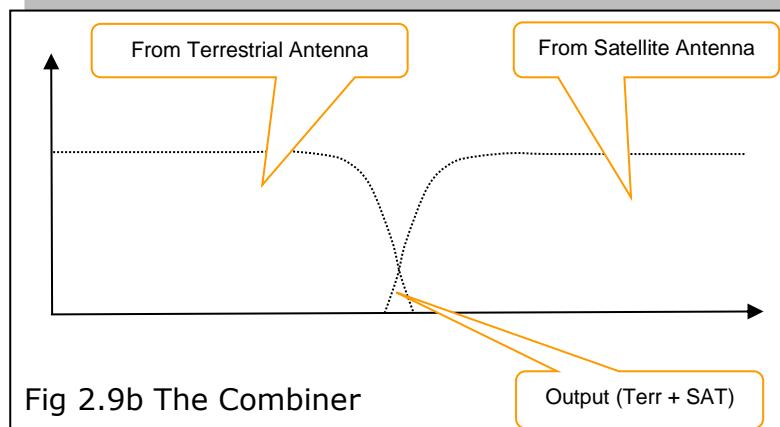
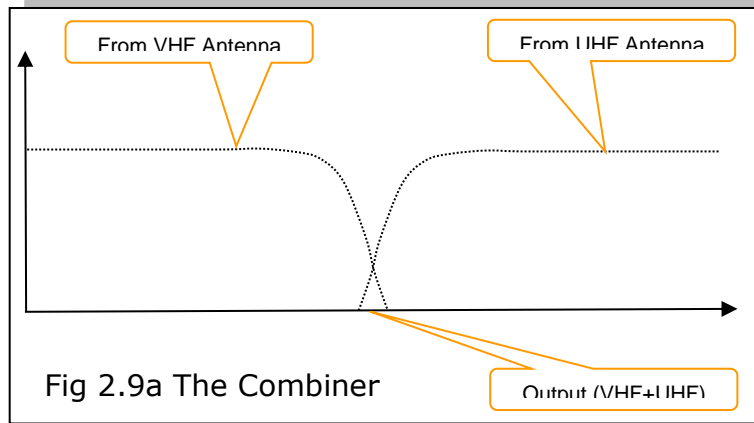

## 2.4 Mismatches

### 2.4.1 Characteristic Impedance

When dealing with cable distribution systems we will notice that all the equipment used has a characteristic impedance of 75 Ohms.

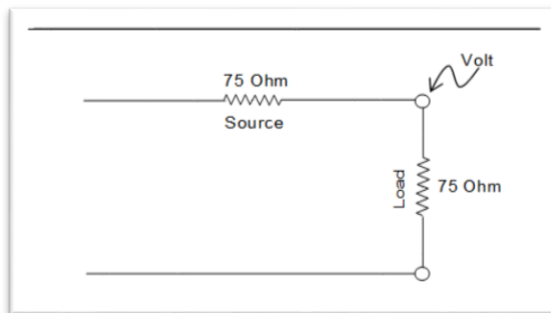
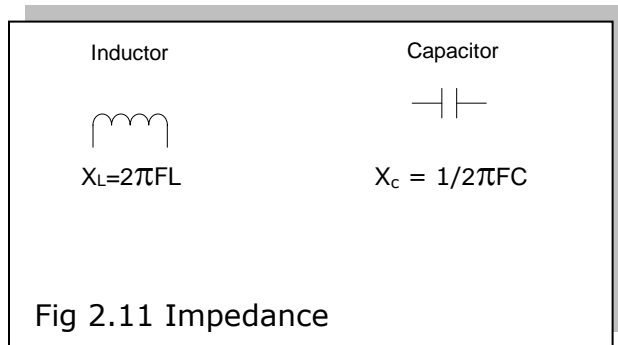

Fig 2.10 A resistive load

The diagram in figure 2.10 shows a purely resistive load. We will use this for the explanation. We note that the source has a resistance of 75 Ohm and the only way that the power can be transferred from the source to the load without any losses is when the load is at the same resistance.

As mentioned earlier the components used in a cable distribution system do not only contain resistors, but two other components known as inductors and capacitors. Furthermore we are dealing with frequencies that cause the impedance (“resistance”) to change across the capacitors and inductors. Fig 2.11 explains what happens without any mathematical calculations as they get complex because we deal with formula containing “imaginary” numbers.



Looking at the formula for “ $X_L$ ” you will notice that the frequency value (“F”) is part of the multiplication and when the frequency is increased the value for (“ $X_L$ ”) will get bigger. And if we take a look at the formula for “ $X_C$ ” we notice that (“F”) is below the division line and thus as frequency increases the value of (“ $X_C$ ”) will get smaller.

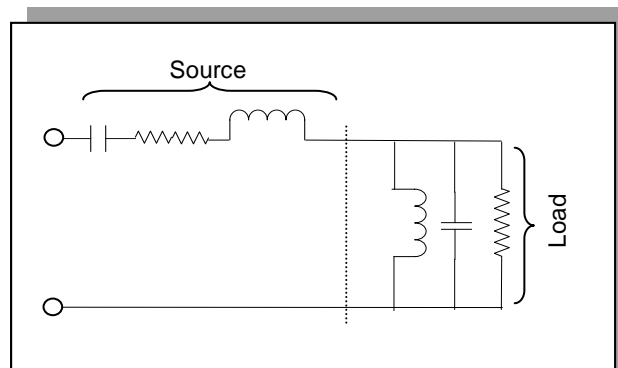

Fig 2.12 Simplified impedance setup

Fig 2.12 is an indication of what a system component will show as far as impedance is concerned.

## 2.4.2 What are Mismatches

In simple terms mismatches occur when the source and load impedances (“resistances”) of a system are not the same. What this means is that the source impedances, the impedance of the cable and the load impedances are not matched. In practical terms this means that all the power (or “signal”) is not transferred from one device to another and some of this power is reflected back from the source to the load.

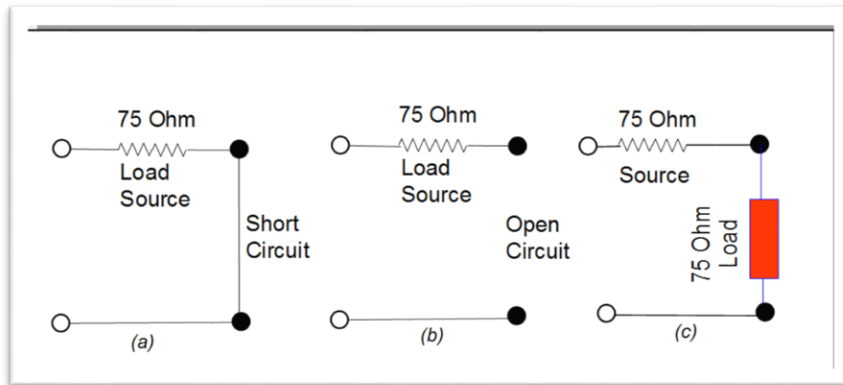

Fig 2.13 Impedances Mismatches

Figure 2.13 above shows the extremes of mismatches that can occur in a system. Figure 13(a) shows a short circuit for the load. When we get a short circuit the voltage collapses and this causes a very high current (amps) to be reflected back to the source. The full voltage amount is reflected back to the source, but is  $180^{\circ}$  out of phase. The full current is also reflected back to the source.

Referring to figure 13(c) we will see that the system is balanced and no reflections will occur.

If we however, now refer to figure 13(b) we will see that the open circuit allows no current (amps) to flow. When this happens all the amount of voltage is reflected back to the source. The whole amount of current is also reflected back, but is  $180^{\circ}$  out of phase.

What we notice now is that if the characteristic impedance of a system is not matched we have power loss or, simply stated, signal is wasted.

### 2.4.3 VSWR

This term VSWR stands for “Voltage Standing Wave Ratio”. This occurs when there is a mismatch between the source and the load. The bigger the mismatch the bigger the VSWR reading will be.

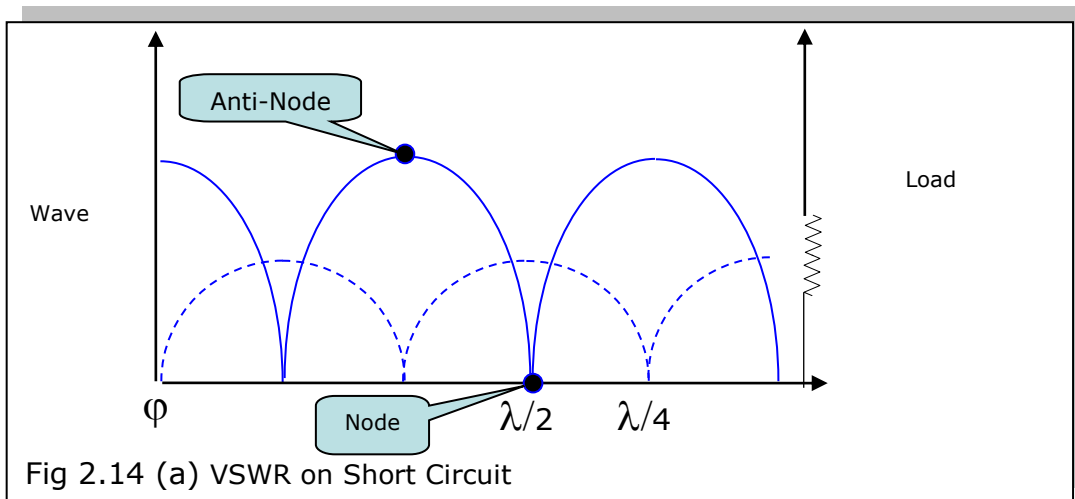

The easiest way for calculating the VSWR is;

$$R_{\text{source}}/R_{\text{load}} \text{ or } R_{\text{load}}/R_{\text{source}} \text{ (largest value on top)}$$

From figure 2.14, we will notice two points, namely the *node* and the *anti-node*. The VSWR expresses expression of the difference between these two levels. Figure 14(a) shows the situation where the *node* is zero as this is an extreme case where the load is a short circuit. The VSWR goes high (infinity), as the value of  $R_{\text{load}}$  is zero.

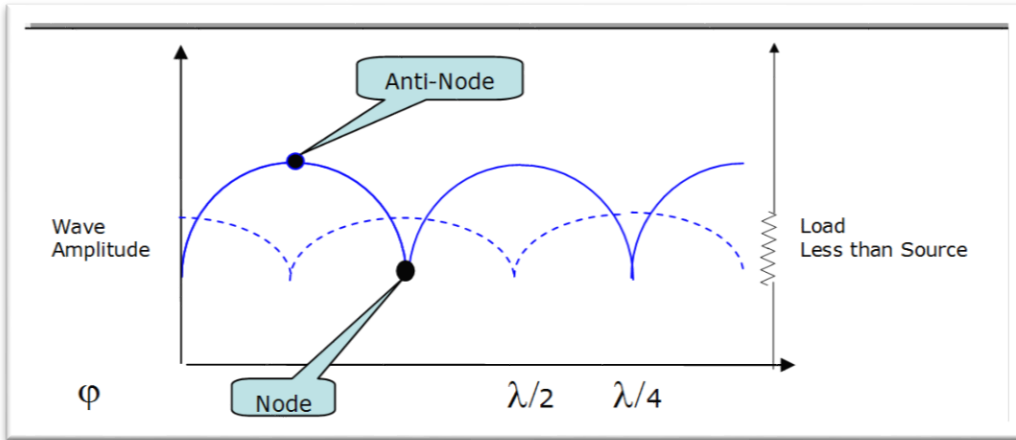

Fig 2.14(b) VSWR with Load slightly bigger than the Source Impedance  
 Figure 14(b) shows the resistive value of the load is slightly less than the source resistance and we will now notice that the node is not at zero, but has a different value. The closer together the source and load resistances are in value the closer the *node* and *anti-node* will thus the smaller the value of VSWR.

(NB. When the load and source resistances are equal the lines in the above graph are straight and the VSWR value equals one.)

#### 2.4.4 The Reflection Co-efficient

We define the reflection co-efficient as the linear expression of the amplitude (level) of the reflected signal against the amplitude (level) of the incident (wanted) signal.

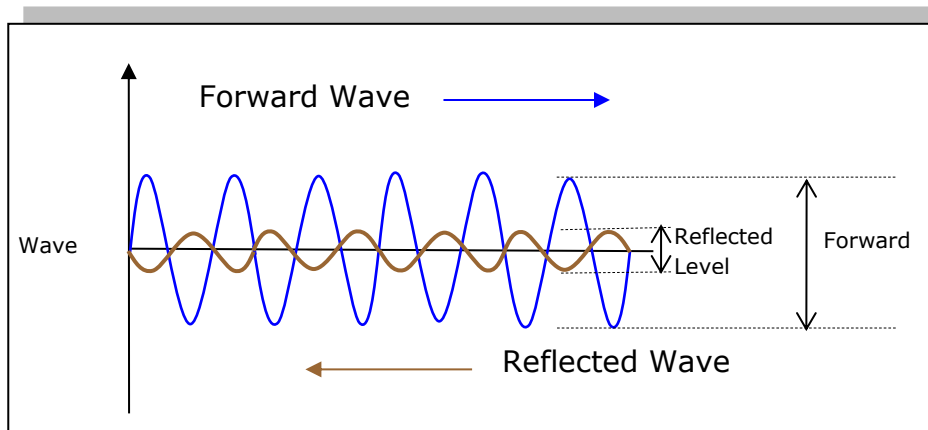

Fig 2.15 Reflection Co-efficient (Linear)



If we refer to the above diagram we will notice that the forward (incident) wave is higher than the reflected wave. Three formulas may be used to determine this level namely;

$$\frac{V_{REFL}}{V_{FORWARD}}$$

$$\frac{(Z_{LOAD}-Z_{SOURCE})}{(Z_{LOAD}+Z_{SOURCE})}$$

$$\frac{(VSWR-1)}{(VSWR+1)}$$

## 2.4.5 The Return Loss

The return loss is regarded as the logarithmic value of the reflection co-efficient.

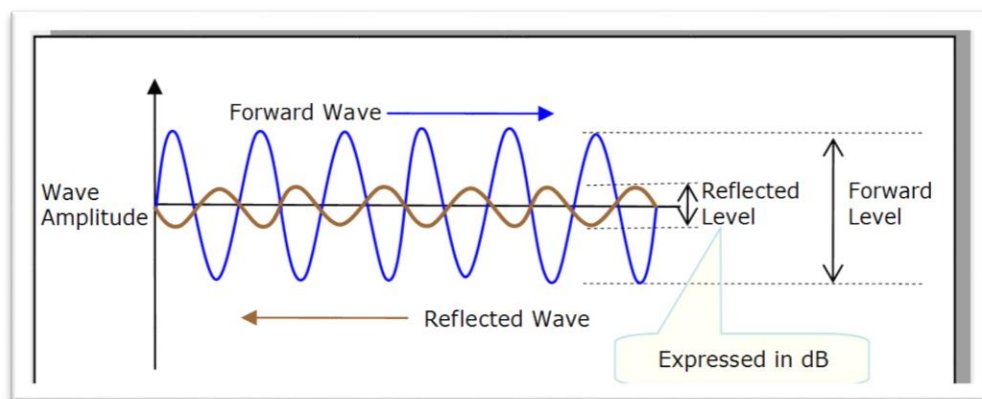

Fig 2.16 Return loss (Logarithmic)

The formula to use is as follows;

$$RL = -20 * \log_{10} \left( \frac{Z_{SOURCE} + Z_{LOAD}}{Z_{SOURCE} - Z_{LOAD}} \right)$$

Even when the answer is negative, the answer is expressed as a positive value. The higher this value the better the matching of the system is.

## 2.5 Distortion

### 2.5.1 Intermodulation

The effect of Intermodulation is a very noticeable in an analogue television picture. It's usually displayed as a Moiré' (small herring bone) lines. It is caused by the mixing of the in-band video signal by either adjacent channel frequencies or a frequency entering the band from the environment.

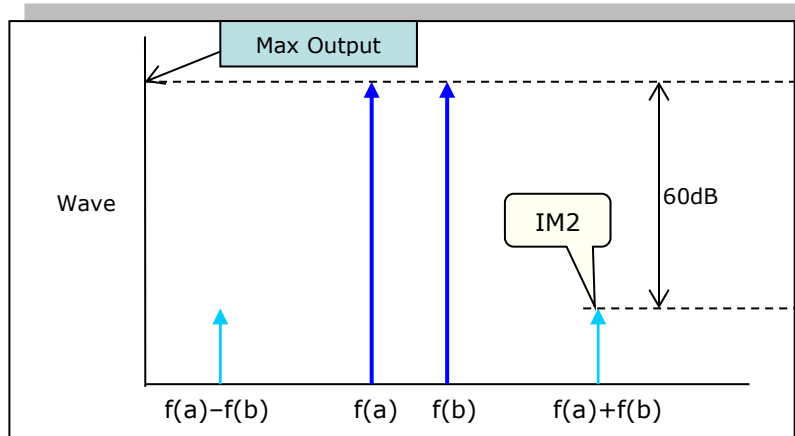

Fig 2.17 (a) Intermodulation (IM2)

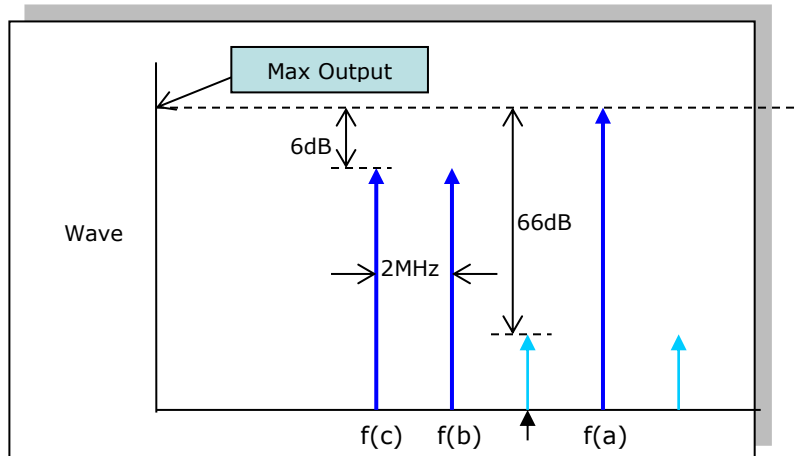
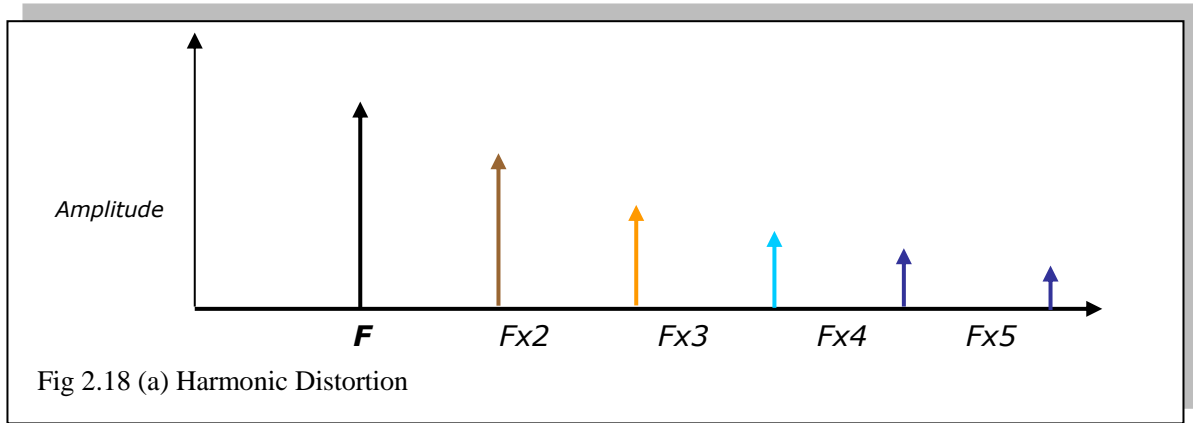

Fig 2.17 (b) Intermodulation (IM3)

The above two diagrams shows that there are two different intermodulation products that are used namely the second order (IM<sub>2</sub>) and the third order (IM<sub>3</sub>). Notice the levels of the intermodulation products. When the ratio gets smaller then interference could be noticed in the analogue TV picture.

### 2.5.2 Cross modulation

Cross modulation is referred to as interferences that are generated when harmonic distortion takes place.



When you over drive an amplifier, i.e. (output level too high), the frequencies that are harmonically related to the wanted frequency will be generated. We notice from figure 18(a) that the frequencies are multiples of the wanted frequency.

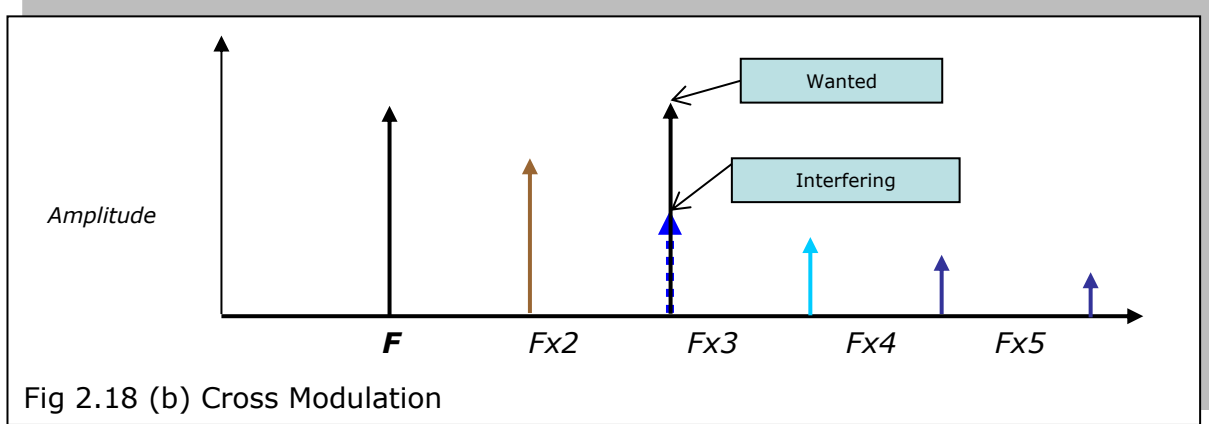

From figure 18(b) we can see that these frequencies can now interfere with another wanted frequency.

### 2.5.3 Sync Pulse Compression

The analogue TV video signal contains a sync pulse which triggers the scanning process.

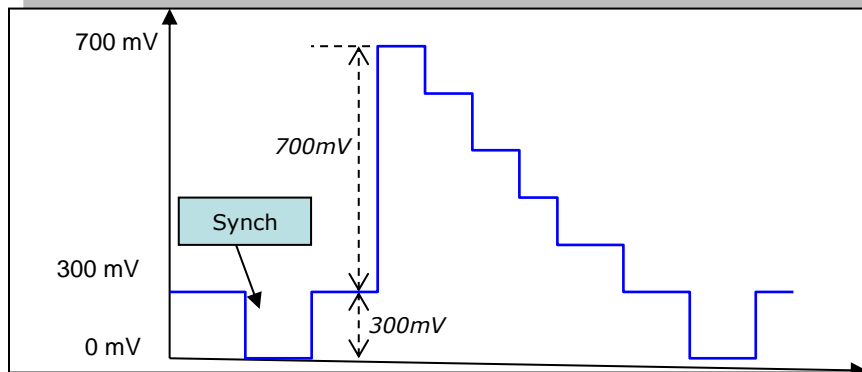

Fig. 19 (a) Normal Sync Pulse

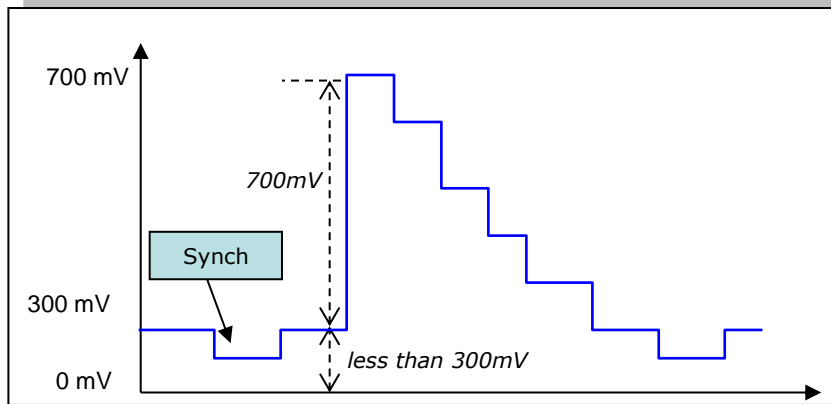
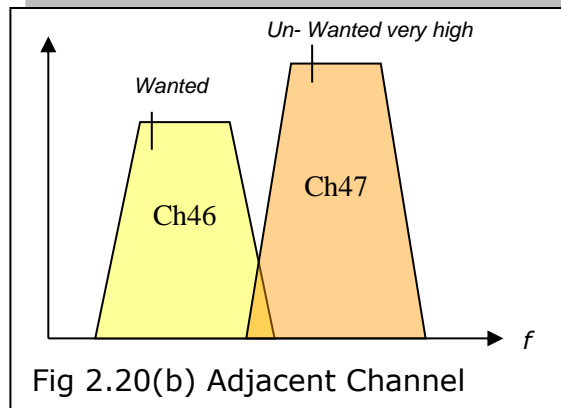
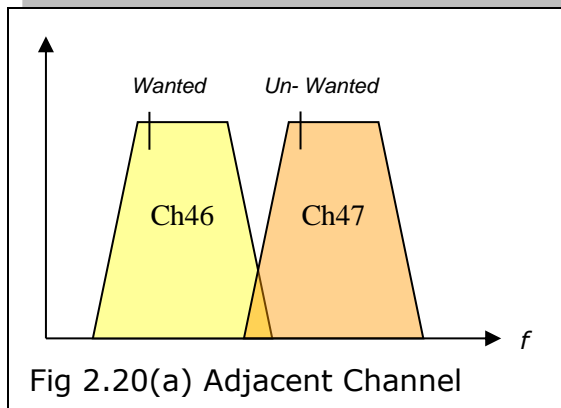

Fig. 19 (b) Compressed Sync Pulse

The sync pulse has a nominal value of 300 millivolts. In an overdriven amplifier the sync pulse could be compressed (made smaller) and this could cause some TV sets to lose lock and we end up with the picture rolling or being distorted.

### 2.5.4 Adjacent Channel Interference

This normally happens when two channels are next to each other. If for instance, we have, channel 47 and channel 46 in the system, we could notice one picture rolling past the other television in the background. This normally happens if the two programmes are from different sources. This problem of this type usually occurs because the slope of the input filters in the TV set is not steep enough to discriminate between the two channels and will worsen if the unwanted channel is at a higher level than the wanted channel.



When the two programmes are from the same source they will be “gen-locked” which means that a steady faint picture might be noticed in the background.

### 2.5.5 Hum Bar Interference

This interference is seen as a faint bar, sometimes slightly lighter and sometimes slightly darker in colour that moves from the top to the bottom of the screen.

It’s usually caused by power problems that originate in one of the power supplies in the system usually with poor regulation.

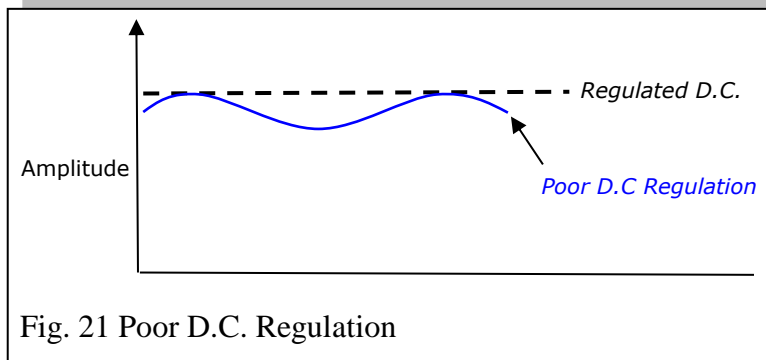

## 2.6 Noise

### 2.6.1 What Is Noise?

We can classify noise into two groups and call them *atmospheric* and *man-made (electronic or thermal)* noise.

Firstly, let's consider the *atmospheric noise*. We are surrounded totally by this noise in the atmosphere and this is largely due to molecular movement.

We can include *cosmic noise* as generated by the galaxy under this heading. This type of noise is created by the radiation from the sun and the stars. This type of noise is where the signals we want to receive will have to travel through. It has a presence across the frequency spectrum so some of this noise will be present in the signal we need to receive.

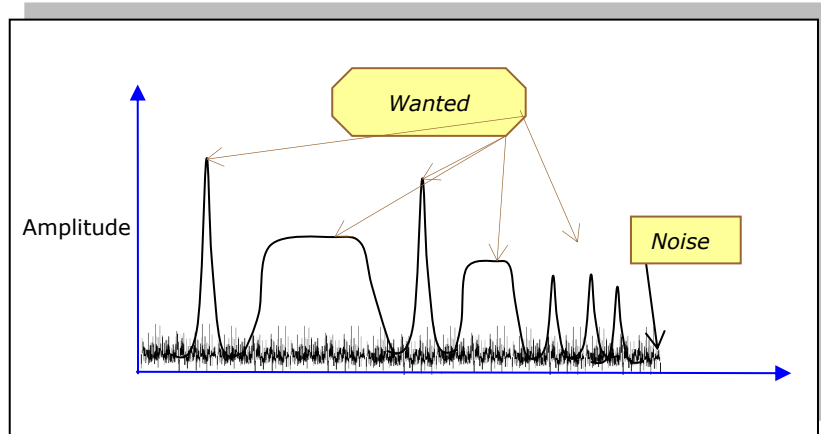

Fig 2.22 Atmospheric Noise

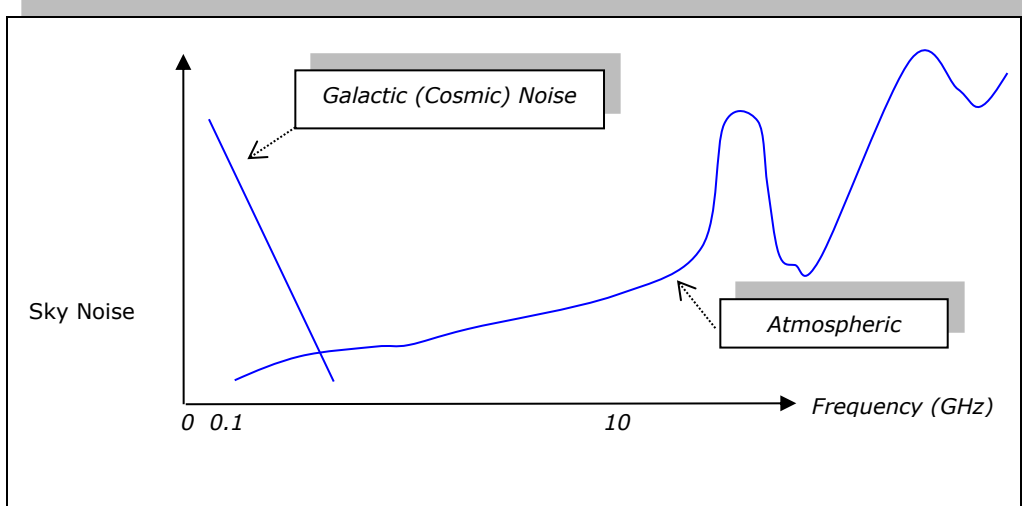

Fig 2.22 (b) Noise Graph

It therefore is very important to ensure that the levels of the signals we receive are optimized so that we can receive the highest possible signal. Secondly we then deal with man-made (or thermal) noise which is present in all the electronic equipment we use. It's important to note that the higher the amplification in an amplifier the higher the noise will be. Again this type of noise is not created in passive devices, but we will see that passive devices do form part of the noise calculations.

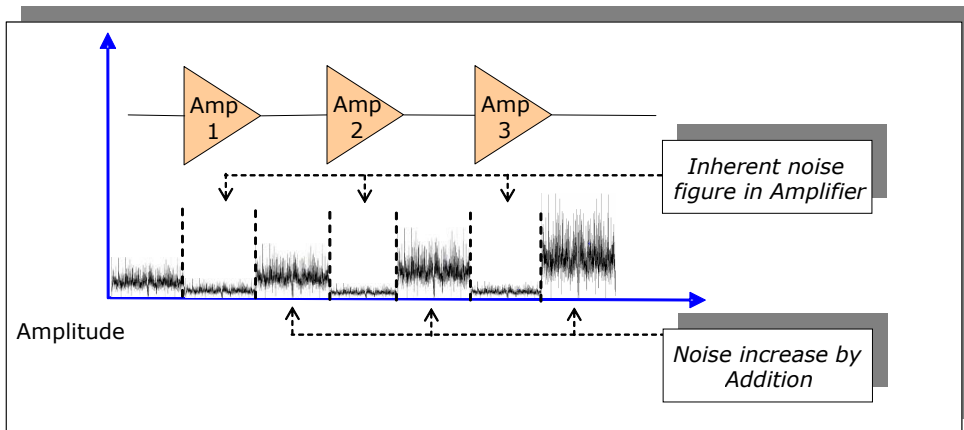

Fig 2.23 Noise in Amplification

Referring to Fig 2.23, we will see that the noise in a system adds together. That is the reason why it is important that all signals that are amplified are not close to the noise floor as this will create poor picture quality. The formula that follows will demonstrate how the combination and placement of different amplifiers will affect the system noise figure.

### 2.6.2 Bandwidth and Noise

If we refer back we must have remembered that noise is randomly present across the whole frequency spectrum. As we deal with noise power it makes sense to realize that the greater the frequency range (*bandwidth*) we are dealing with more noise power will be available.

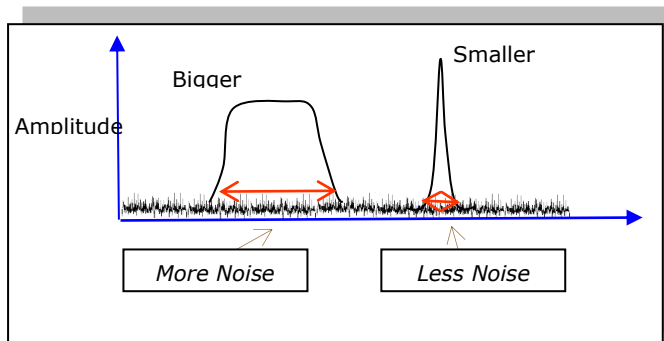

Fig 2.24 Bandwidth and Noise

If we take a look at this simplified formula for the noise power calculation;

$$P_n = kTB \text{ watts}$$

[k = Boltzmann's constant ( $1.38 \times 10^{-23}$ ), T = absolute temperature ( $290^{\circ}\text{K}$ ) and B= bandwidth in Hertz]

Note that, if we increase the value of "B", the noise power ( $P_n$ ) will also increase.

### 2.6.3 Carrier to Noise

When we distribute or receive a signal we deal with two concepts. We want firstly to receive a good signal and then secondly we do not want any noise interference reducing this quality of signal.

The ratio of the level of the signal (carrier) expressed against the amount of noise in decibels is known as the *carrier-to-noise*.

This is defined by the formula;

$$C/N \text{ (dB)} = 10 * \log(\text{carrier/noise})$$

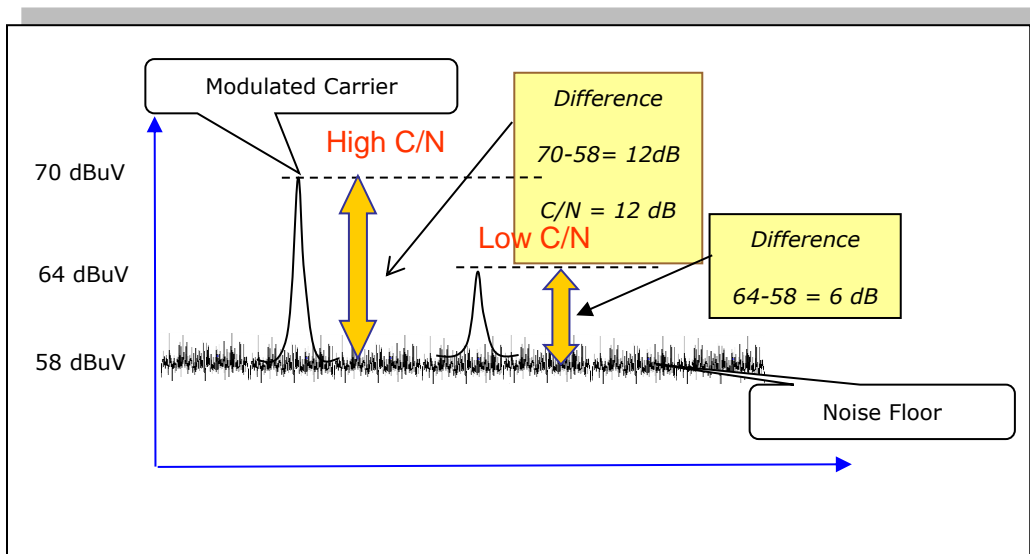

Fig 2.25 Carrier to Noise Ratio



When we are measuring this value we are actually measuring carrier plus noise divided by noise  $[(C+N)/N]$ , but this is not important unless the value of  $C/N$  is very low. There are a number of concepts that are used in the definition of  $C/N$ , but as we are dealing with television cable systems we will regard the  $C/N$  as the measurement of the modulated radio frequency carrier level relative to the noise floor.

We will discuss later the differences between  $C/N$  readings in analogue and digital signals.

#### 2.6.4 Signal to Noise Ratio (SNR)

The measurements of signal to noise ratio are done at base band either before modulation onto the RF carrier or after de-modulation from the RF carrier.

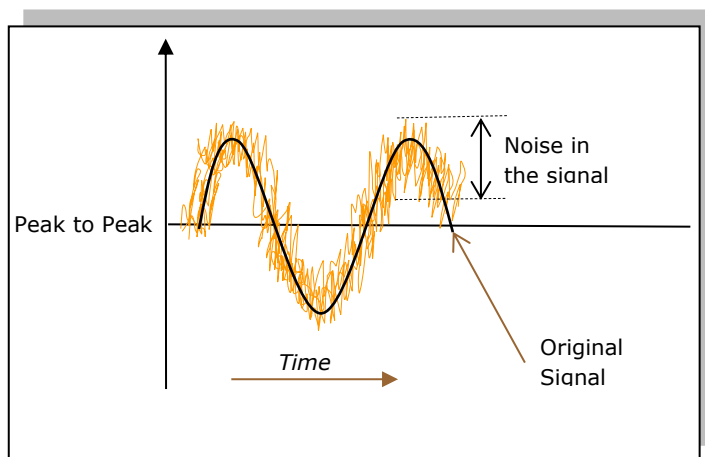

Fig 2.26 Signal to Noise

From figure 2.26, above, we can relate the signal to noise reading on the base band as the “fuzziness” around the required signal. This is seen as faint grainy interference in an analogue TV signal, but may not be noticed in a digital system until a level is reached where the receiver cannot read the digital bits and drop outs start occurring.

## 2.7 Frequency and Wavelength

### 2.7.1 The Speed of Light

Light travels at a speed of  $3 \times 10^8$  meters in a second.

We need to remember that light as well as the frequencies we use are composed of the same electro-magnetic waves, but operate at various different frequencies.

**RECAP:** Remember that frequency is defined as the number of oscillations that occur in one second.

What does this mean when doing television system installations?

We can now apply, this phenomenon, to calculate a very important part of the transmission of television signals, namely the wavelength.

### 2.7.2 Calculating Wavelength

What is wavelength?

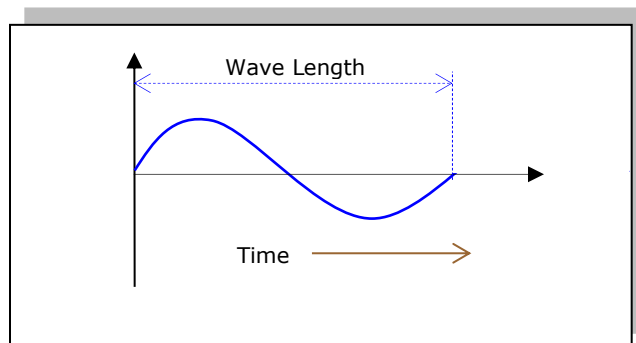

Fig 2.27 Wavelength

From figure 2.27 we can see that the wavelength is measured for one complete cycle of a signal. Now, we have two factors, namely frequency and the speed of light to consider. Both these factors are referenced to time (i.e. one second) which gives us the following formula;

$$\text{Wavelength} = 300/\text{MHz}$$

We now know that light travels at 300 million meters in a second and the frequency vibrates at a certain number of cycles per second we can calculate the length of each cycle.

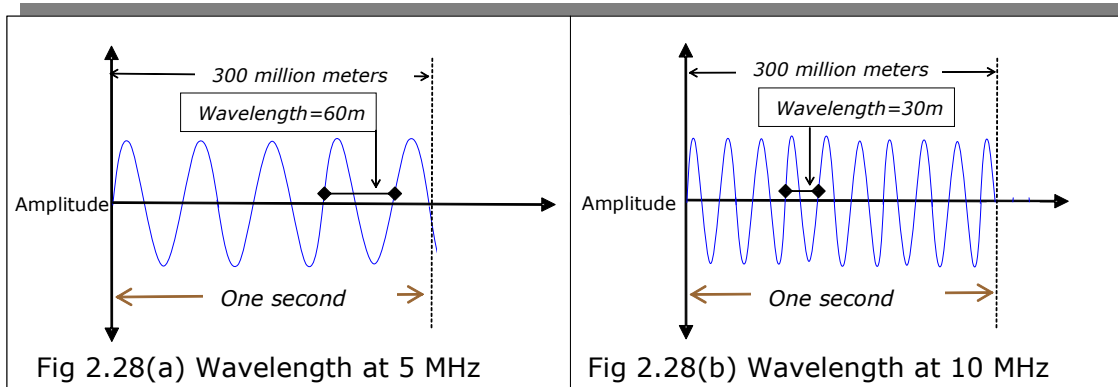

Figure 28(a) represents a frequency of 5 MHz and we will see that the wavelength is;  
 $300/5 = 60$  meters

Figure 28(b) shows a frequency of 10 MHz and now we will see that the wavelength is;  
 $300/10 = 30$  meters.

We can notice that if the frequency is increased the wave length will become shorter. Wavelengths are an important factor as they have an effect on reflections, antenna design and the phasing discussed in the next section.

### 2.7.3 The Phasing of Signals

Signals can end up being in-phase or out-of-phase because of the wavelength. The impact of this is that we may end up with the cancellation of signals or the addition of signals. This may result in “ghosting” on analogue signals or the corruption of data on digital signals.

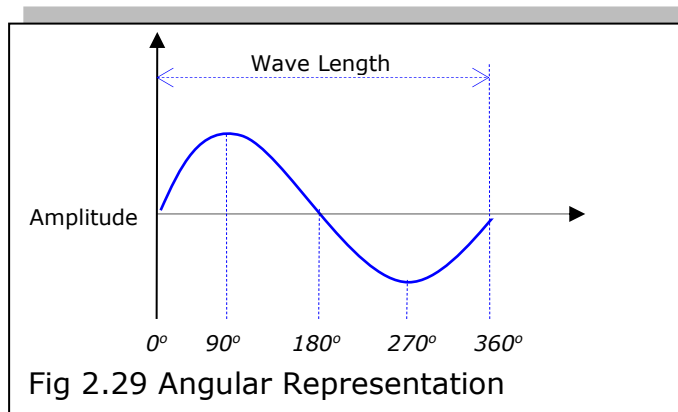

From figure 2.29 we see that the sine wave can be divided into angles which are derived from a standard sine wave formula. If one of the signals gets delayed (time difference) in relation to another and then are added at a common point the signals will interact as shown the diagrams below.

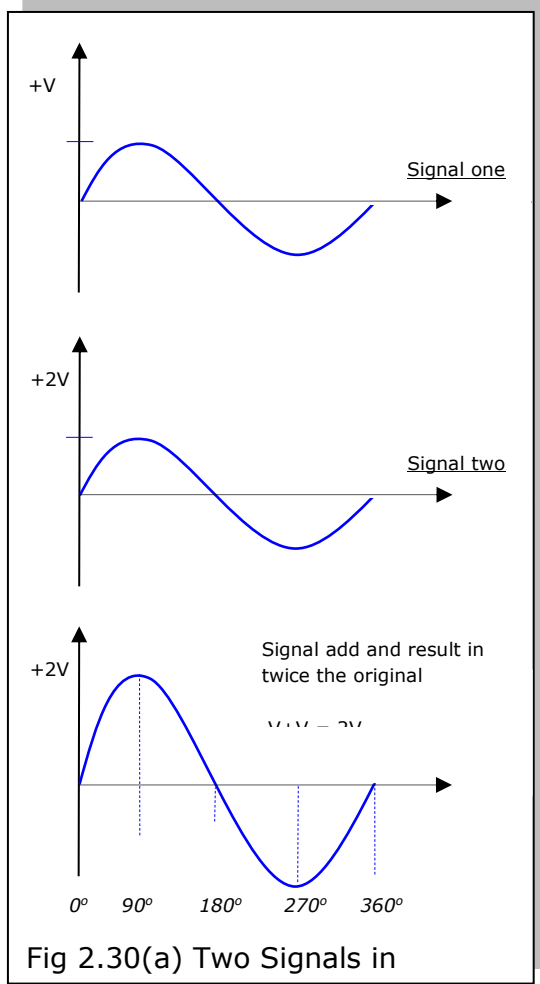

Fig 2.30(a) Two Signals in

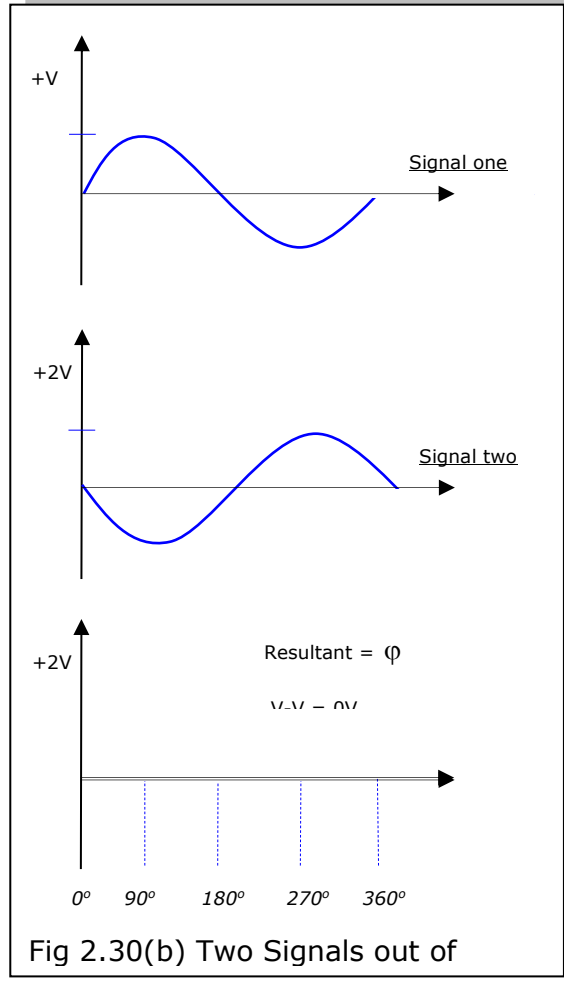
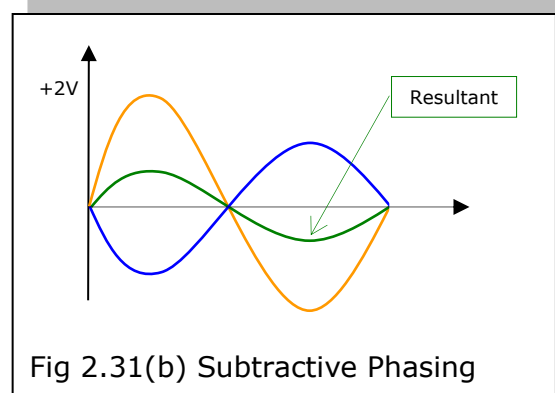
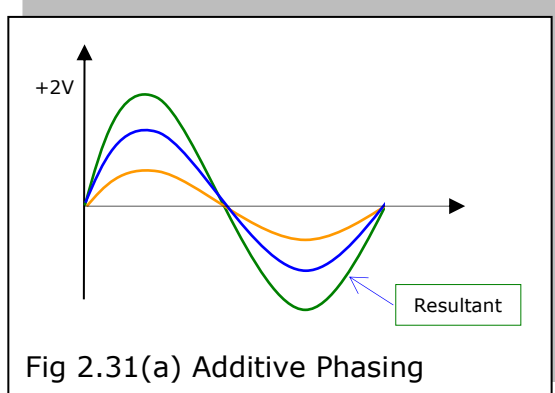

Fig 2.30(b) Two Signals out of

The above diagrams show the extreme cases of phasing.



The diagrams above show the additive and subtractive phasing when the two signals are not at the same level which is a more common practical occurrence. Later on we will see how it affects installations and how to it can be overcome.

## 2.8 Television Standards

*(The modulation methods will be discussed in-depth in section 1.12)*

### 2.8.1 PAL

PAL means “phase alternate line” and it is a form of analogue transmission and video. If we look at the diagram below, figure 2.32, it will be noticed that the picture is made up of horizontally scanned lines. This happens very fast that the eye thinks we are seeing a complete picture. Due to bandwidth constraints and the need to reduce flicker the system of interlaced sequential scanning is used which implies that first all the odd numbered lines are scanned and then the even numbered lines.

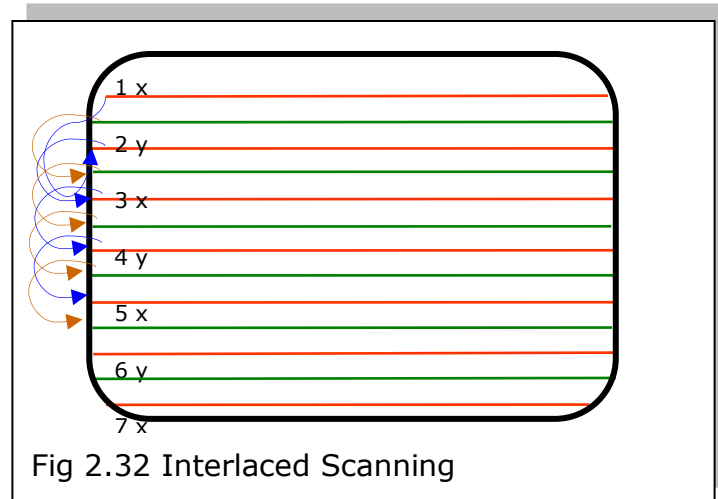

The interlaced scanning creates the idea that the pictures occurring at 25 times a second are being shown at 50 times a second.[1]

When, however, colour pictures are transmitted the colour carrier employs quadrature modulation which means that if any phase shift occurs this will result in variances in the colour. This problem can be overcome by inverting one of the vectors of the colour carrier on every alternate line of the picture which then averages out any phase shifts that occur and so any unwanted changes in colour are eliminated. Hence the acronym PAL (phase alternate line).

### 2.8.2 B/G or I

Two main standards of PAL transmission are used, namely “B/G” or “I”. They refer to the spacing between the vision and sound carriers on the RF modulated signal. When we talk of “PAL B/G”, the “B” refers to the channel separation of 7 MHz on the VHF channels and “G” to a channel separation of 8 MHz PAL B/G also refers to a sound and vision carrier separation of 5,5 MHz

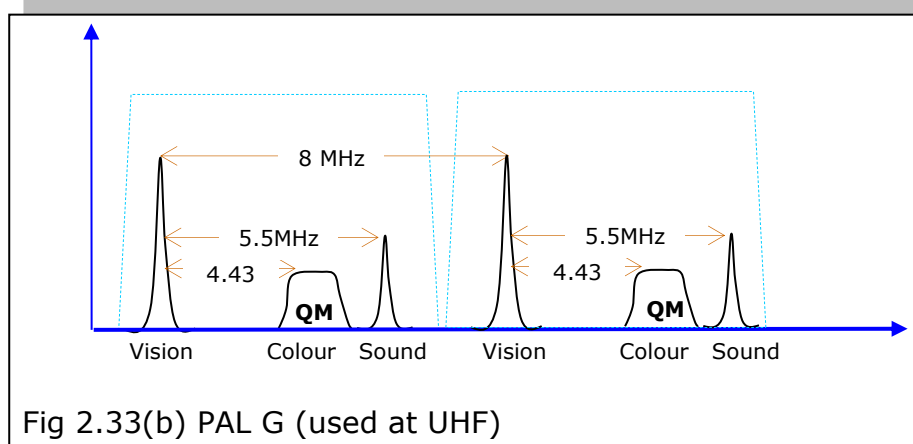
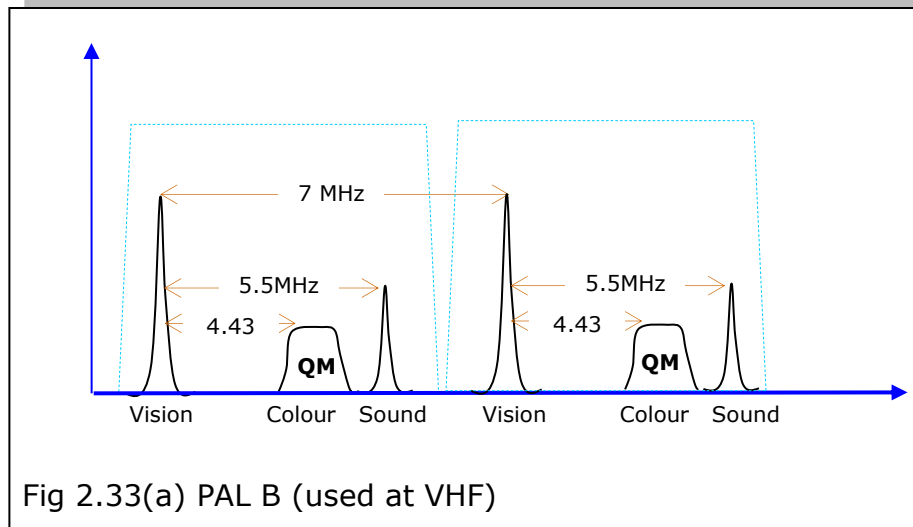

In the case of “PAL I”, standard differs in that the sound and vision carriers are 6 MHz apart and the channel separation is 8 MHz

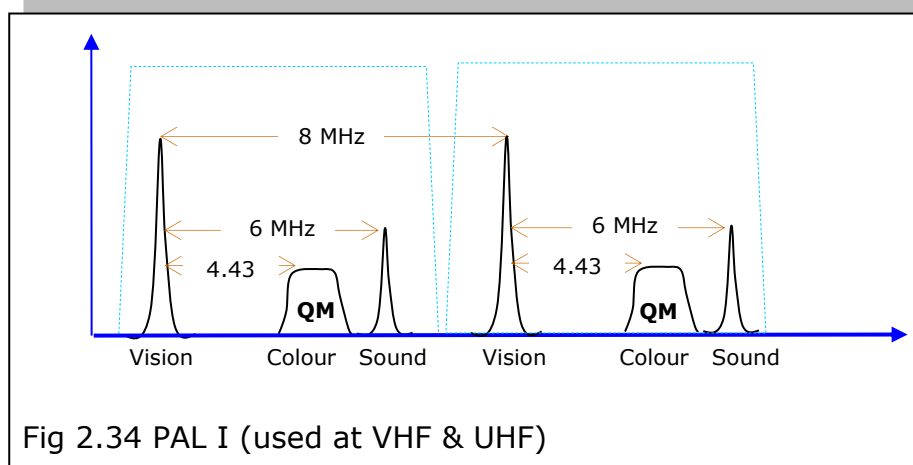

In the case of “PAL” system the vision carrier is amplitude modulated, the sound is frequency modulated and the colour sub carrier is quadrature modulated with a suppressed carrier.

### 2.8.3 SECAM

This SECAM system was invented by the French and used mostly in French speaking countries. It is similar to the “PAL” system, but the differences are that the colour sub-carrier is frequency modulated and the two colour difference signals are transmitted sequentially.

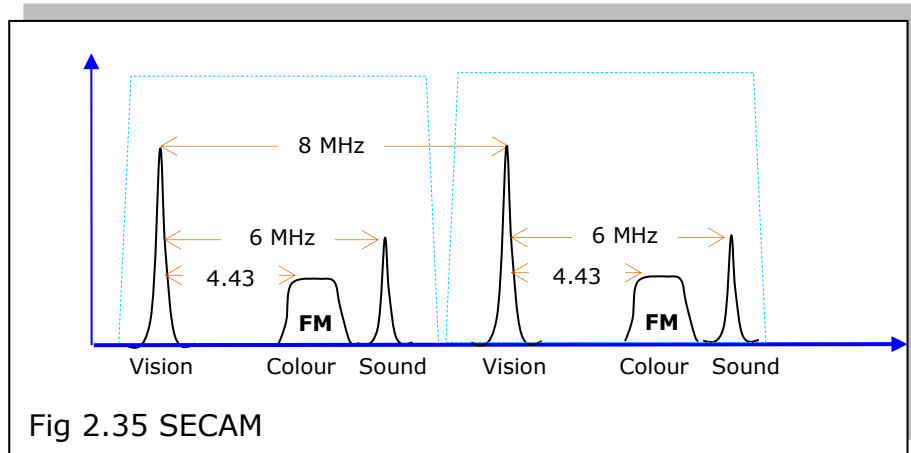

### 2.8.4 DVB-S

The DVB-S standard is used for digital satellite transmission and uses the modulation method known as QPSK (quadrature phase shift key).

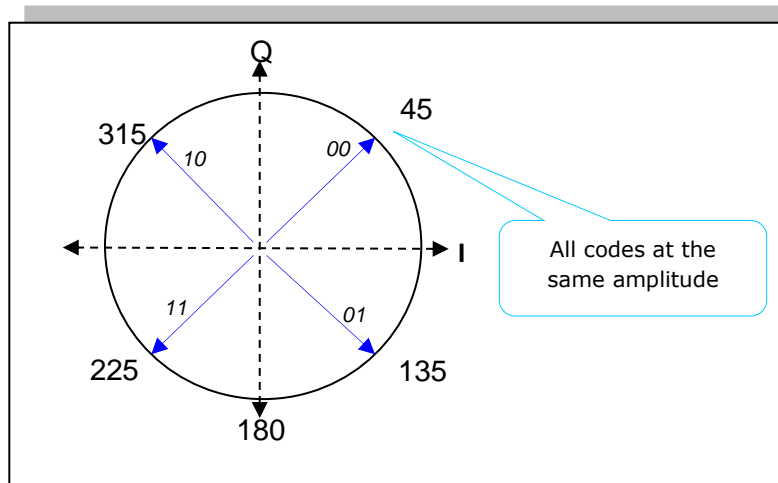

Fig 2.36 DVB-S Phase Relationship



This modulation standard was chosen due to the long distance (36000 km) the signal has to travel and due to the severe noise interferences that are encountered due to the signal loss of about 205 dB that is encountered.

The satellite transponder also shows non-linear response so that no modulation that uses any form of amplitude coding can be used as the information received will be incorrect.[1]

### 2.8.5 DVB-S2

This is an upgraded version of the DVB-S standard that is used for satellite television transmission. The main difference between “DVB-S” and “DVB-S2” is the data transmission rate and although the QPSK method is still used it is now referred to as 8PSK. This allows for a higher data transmission rate in give bandwidth. The error correction used is also totally new and differs from the method used in the QPSK method.

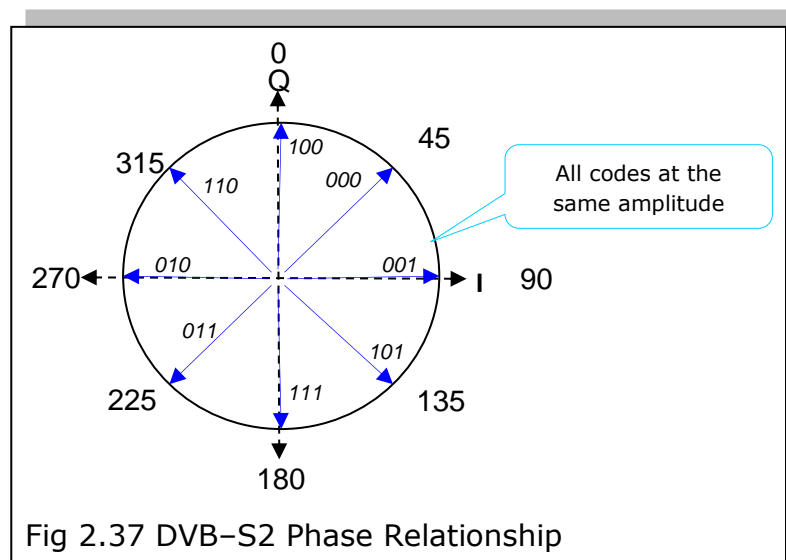

8PSK allows for the transmission of HDTV without increasing the bandwidth required for the extra data required. The DVB-S2 (8PSK) is totally backward compatible with QPSK.

### 2.8.6 DVB-C

This is the specification that is used to transmit the digital signals in a cable network and means “digital video broadcast-cable”. The method used for this broadcast is known as QAM (Quadrature Amplitude Modulation).

This system is used exclusively in cable networks.[2]

This system allows many digital programmes to be transmitted within the standard 8 MHz bandwidth that is used for a single analogue channel.

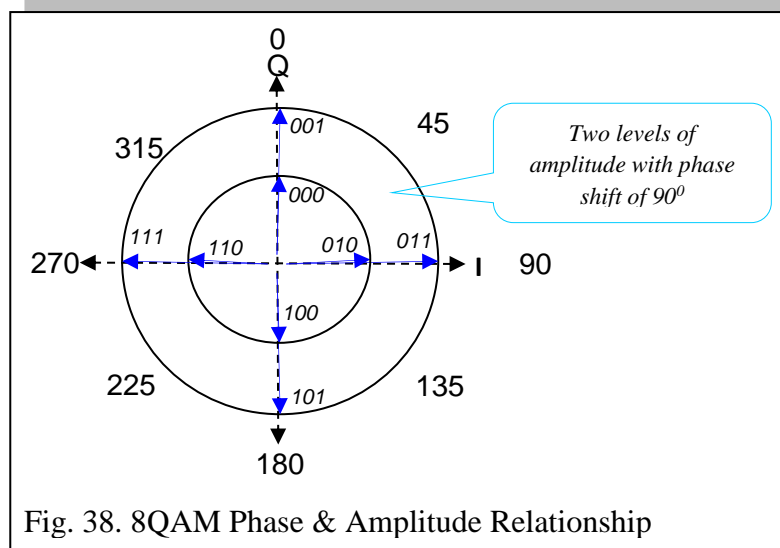

### 2.8.7 DVB-T

This is the standard that is mainly used for the transmission of the digital terrestrial signals. The signals use a transmission system known as COFDM (Coded orthogonal frequency division multiplex). This system is a multi-carrier system that employs the QAM method.

This method is employed for the terrestrial transmission because of the difficulty due to fading caused by reflection paths.

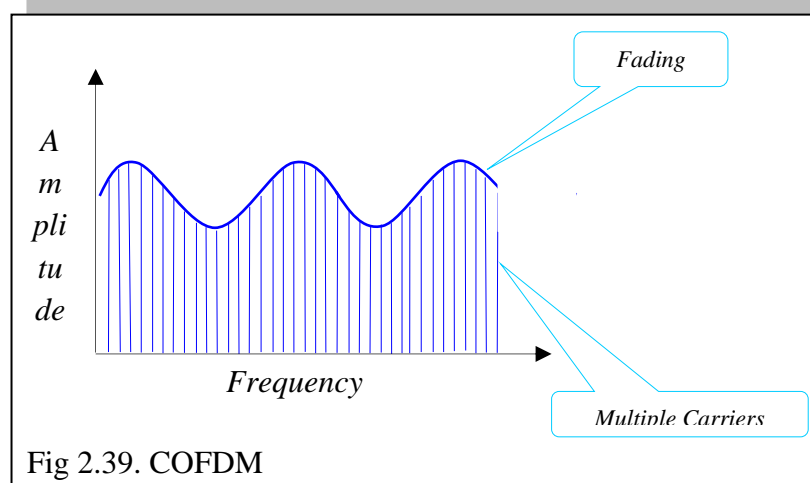

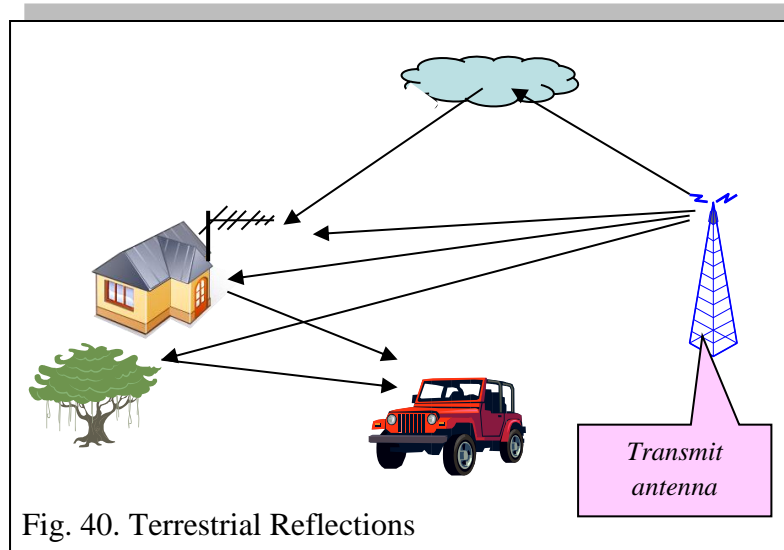

The multi-carrier method is used to overcome the problems caused by;

- *Reflections caused by buildings, mountains etc.*
- *Additive noise*
- *Narrow or wide band interference caused by man-made noise*
- *Doppler effect in mobile radio*

## 2.9 Terrestrial Transmissions

### 2.9.1 Free Space Losses

When a signal is transmitted from a tower it gets weaker as it travels further away from the tower. The signal level is inversely proportional to the distance from the transmitter. The formula normally used to determine the loss of signal versus the distance is;

$$E_0 = 20 \log (7020 * [\text{watts}]^{1/2} / \text{km}) = \text{dBuV/m}$$

assuming there are no obstructions.

The reading obtained from the above process is known as *field strength*, and not, *signal strength*.

When we refer to the expected readings versus distance from a transmitter with an effective radiated power of 10,000 watts we will notice something interesting.

<u>DISTANCE FROM TX (km)</u>	<u>EXPECTED FIELD STRENGTH (dBuV/m)</u>
1	117
2	111
4	105
8	99
10	97
100	77
200	71

**NOTE:** *We are dealing with voltages only so every 6 dB equals half and every 20 dB equals one tenth.*

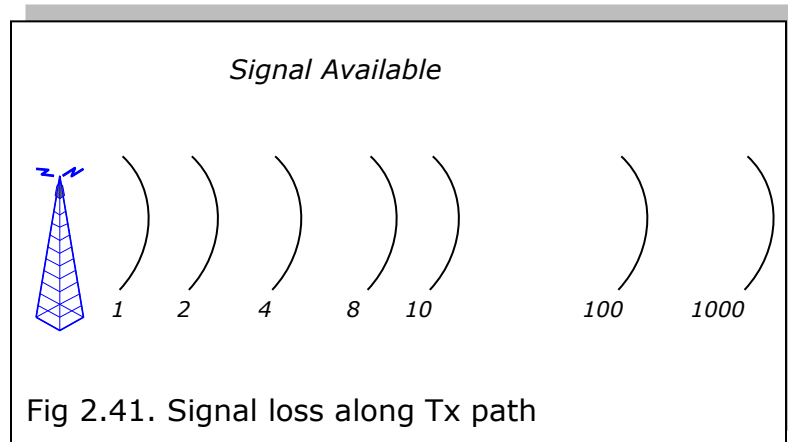

Every time the distance doubled we will notice that the field strength is halved and every time the transmission path is extended tenfold the signal reduces by 9/10 when referred back to the previous point.[2]

## 2.9.2 Signal Strength and Field Strength

When we are taking measurement of a signal on a meter we are measuring a level of signal (signal strength), but when we are dealing with the amount of signal available at a point in space we will refer to field strength.

We will then see that field strength is referred to a length of one meter and the reason for this is to obtain a standard reference for measuring the level contained in the wave front.

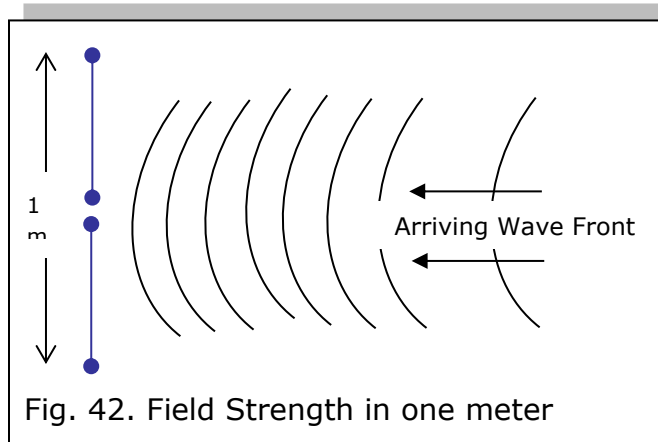

Signal strength and field strength are measured on the peak of the signal (Sync pulse).

Later on we will also see that the signal strength received on an antenna is dependent on the frequency.

### 2.9.3 Digital Carrier Power

This is different from the signal strength as there is no peak power to measure on a digital carrier and this is measured by using the band width.

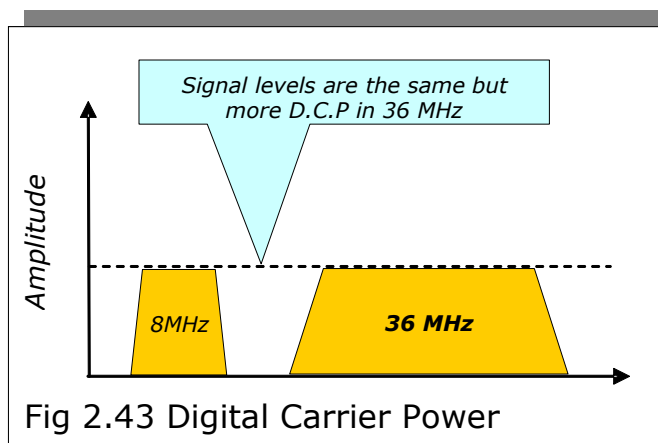

The values obtained are usually higher than the signal strength by a level of 10 to 15 dB when measuring a satellite signal.

## 2.9.2 Terrestrial Antennas

Nearly all the antennas that receive signals are made up of a half wave dipole which now brings out a very interesting phenomenon regarding field strength and signal strength. This phenomenon plays a very important part as the signal strength received at high frequencies will always be lower than the anticipated field strength.

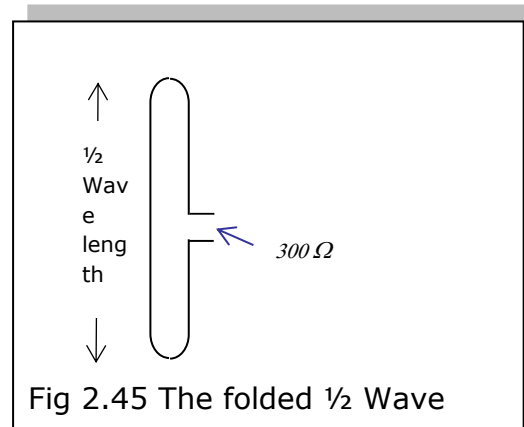
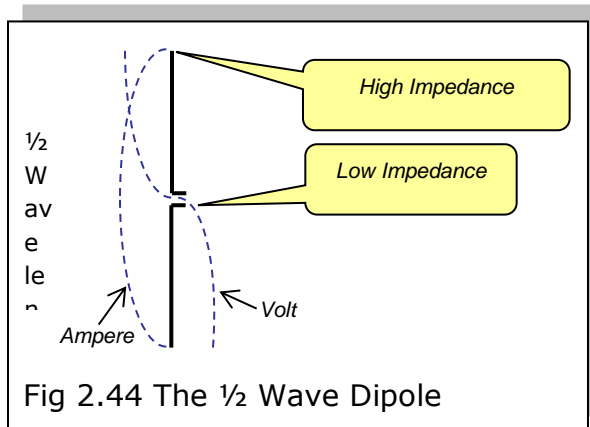

Firstly there is need to realize that both the dipoles are “balanced” devices with impedances that will vary according to the number directors that are used and that the coax cable is an unbalanced device with an impedance of 75 ohms.

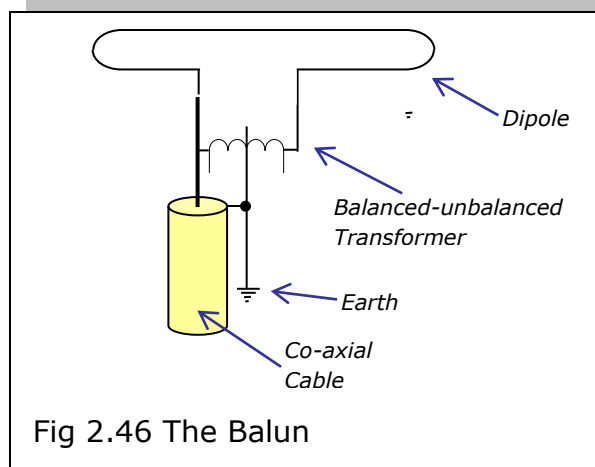

Most of the good terrestrial antenna will always be fitted with the “balun” whose sole purpose is to match the antenna impedance to the coax cable impedance and to provide a proper signal transfer between a balanced and un-balanced device.

*The “**balun**” ensures maximum signal transfer between the antenna and the cable.*

If we, however, now refer back to wavelength calculations and field strength (dBuV/m) we will now see that the dipole is shorter than a meter. We notice that as the frequency increases, the wavelength gets shorter, therefore the dipole, when frequency increases, the dipole becomes shorter and being shorter than a meter intercepts less of the wave front.

We use the following formula to determine the signal strength using a half wave dipole;

$$\text{Signal strength} = \text{field strength} * (\text{wave length}/2*0.95)$$

Or (using dB's)

$$E_{\text{signal strength}}(\text{dBuV}) = E_{\text{field strength}}(\text{dBuV}) - (20 * \log[6.28/\text{wavelength}])$$

## 2.9.4 Reflections

Terrestrial transmissions probably rank among the most difficult to achieve with good signal quality. This is caused by reflections that occur due to signals “bouncing” off objects such as buildings, mountains etc.

The effect is that the reflected signals arrive at the reception antenna later than the wanted signal causing in-phase and out-of-phase additions. In most cases this can lead to signal loss, ghosting on analogue television and data loss on digital terrestrial transmission.

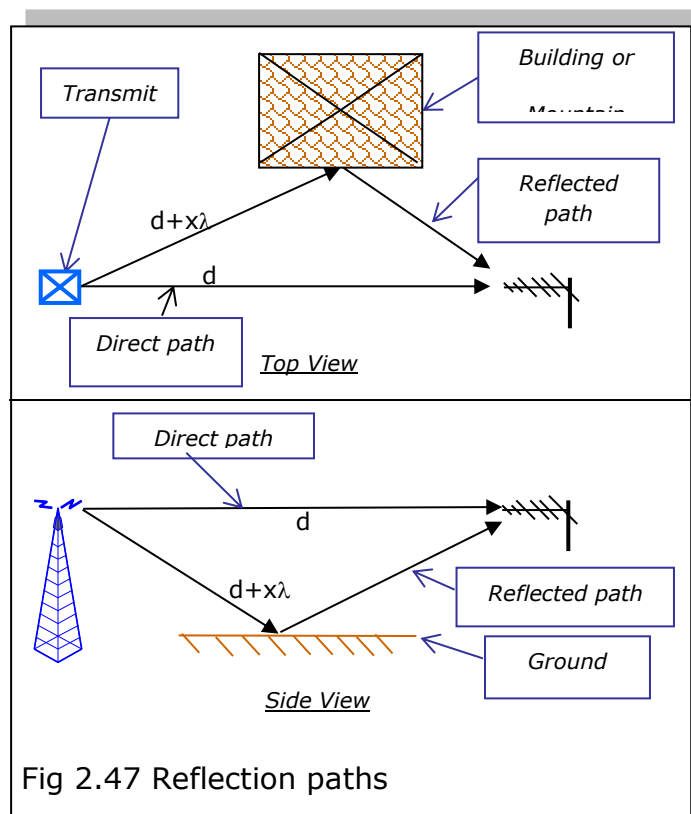

From figure 2.47, above, one can gain a first impression that the path of the reflected signal is longer than the wanted. Now let's refer back to the phasing of signals (*Every frequency has a wavelength*) we will realize that some reflected signals may be problematic depending on the length of the reflected path as this difference in length can cause phasing problems.

## 2.9.5 Diffraction



Electromagnetic waves get diffracted when they encounter the edge of an obstruction. This may be one of the reasons that you are sometimes able to receive signal should you not be in direct line of sight of the transmitting antenna.

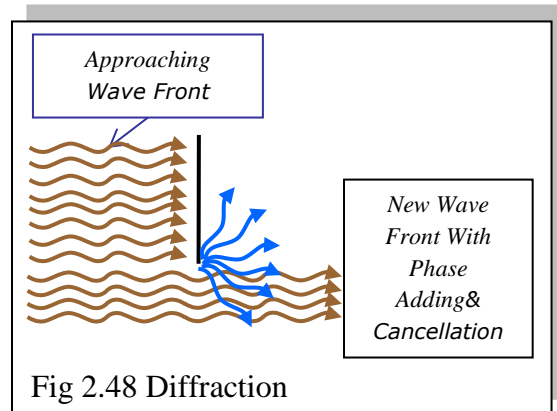
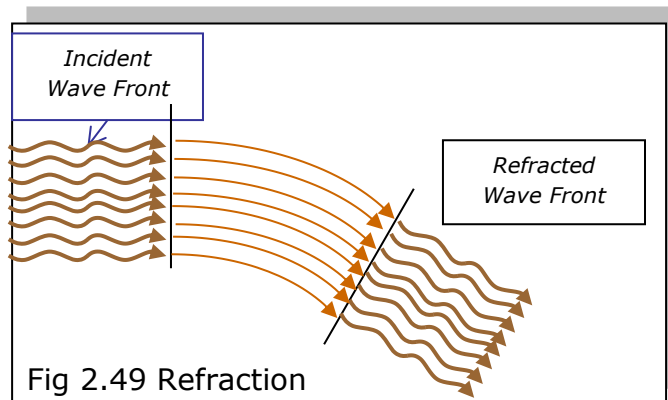

Figure 2.48 shows us that the signal has the tendency to bend around the edge of an object and then scatter. If the incoming signal happens to be strong enough there may be enough of this scattered signal that is usable. The diffracted signal also contains resultants of phasing products.

### 2.9.3 Refraction

Refraction is another phenomenon that occurs to the electro-magnetic wave during transmission and is caused by the wave traveling through mediums of different density. This has an effect of “bending” the wave.



One good example of refraction is the effect we have when a stick is pushed into water and it now seems that the stick has a sharp bend where it has entered the water.

### 2.9.4 Fresnel Zone

Fresnel Zone is another phenomenon that occurs when transmitting electro-magnetic waves. One can think of the Fresnel zone as a “cigar” shaped figure that is created between the transmitter and the receiver. The field strength calculations will only be correct if there is no interference with the first zone.

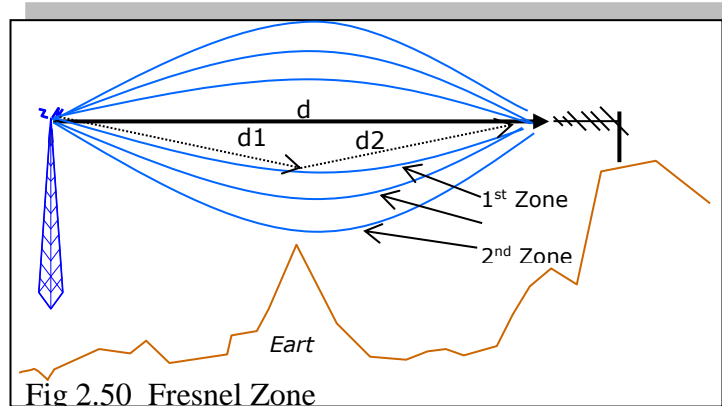

The radius of the Fresnel zone is dependent on the frequency of transmission. The higher the frequency, the smaller the radius of the Fresnel zone. The Fresnel zone however should only be considered on very long transmission paths.

## 2.10 Satellite Transmission

### Free Space Losses

The losses due to transmission we must consider from the satellite transponder are extremely high (in the region of 200 dB) due to long distance that the signal has to travel (36,000 km). It is needless to mention that the signals we are receiving will be very small as will be re-iterated by the chart below.

SATELLITE OUTPUT POWER = 44 dBW (25125 watts)

SIGNAL LOSS = 200db

RECEIVED SIGNAL = -156 dBW

Also, because of the long transmission path, the main obstacle to overcome is the atmospheric noise and the man-made noise to ensure that usable signal-to-noise and carrier-to-noise levels are obtained that will allow for some distribution system degradation.

### 2.10.1 The Reflector

The reflector’s purpose is to “gather” the signals coming from the transponder. It has a similar function as the reflector on a terrestrial antenna, but due to the “dish” shape has the capability of extremely high gain (+/- 10,000 times). This is very important as we are dealing with extremely low signals. The antenna size plays a major part in the gain of the signal and is the easiest way of improving the *received signal level* and the *carrier-to-noise ratio* simultaneously.

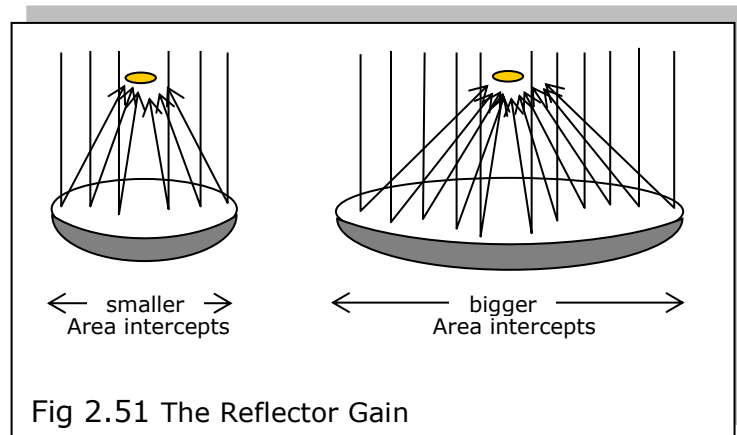

The larger the reflector the more of the wave front it is able to intercept and focus onto the L.N.B. If we refer to the chart below we notice the approximate increase in gain and therefore an increase in carrier-to-noise ratio.

We will use the 60 cm reflector as reference.

**(N.B: Do not think that the 60 cm dish has no gain – it is a reference only!!)**

<u>REFLECTOR SIZE</u>	<u>RELATIVE GAIN</u>
60 cm	0.0 dB

90 cm	3.6 dB
120 cm	6.0 dB
150 cm	8.0 dB

It is important to use a bigger diameter reflector when receiving signals for use in a multiple unit installation as where amplification is used the level of the carrier-to-noise ratio will decrease which in turn worsens the *bit-error-rates* (BER).

### 2.10.2 The L.N.B.

The L.N.B.(Low Noise Block) can be the greatest contributor to the noise in the satellite system as it is the first electronic circuit in the system. The first stage in the L.N.B. is a high gain amplifier which can contribute a large amount of noise. It is very important to install a low noise L.N.B, especially if the system will distribute satellite I.F. The other important factor to consider when installing the L.N.B. is the type that will be required. If all the programs that are required are on the same polarity and band as the home transponder it is possible to install a single port universal L.N.B.

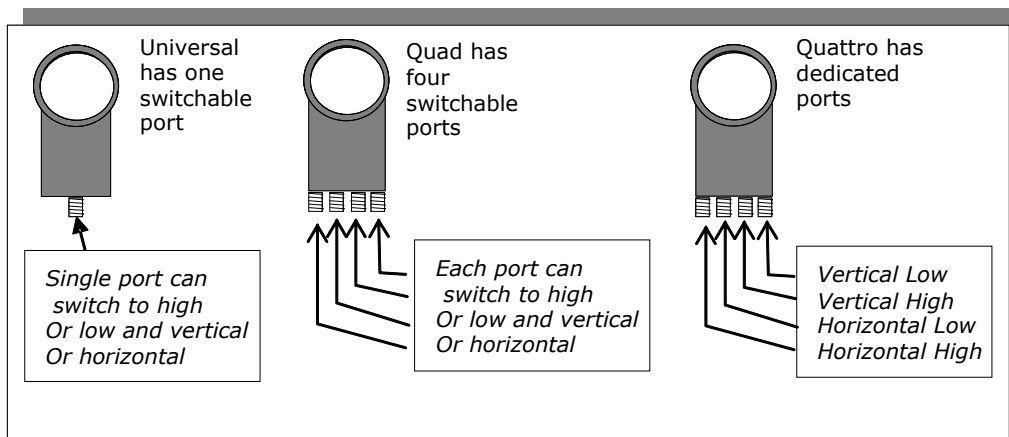

Fig 2.62 Types of LNB's

If however, there are different polarities and frequency bands used it better to install the “Quattro” L.N.B. in conjunction with a switcher so that all the decoders can be accommodated.

### 2.10.3 Polarity and Skew

The setting of the correct skewing is very important as this is the only method that the total system can rely on to discriminate between horizontal and vertical polarization. If this is not done correctly it means that;

1/The wanted signal is not at its maximum.

2/The unwanted signal on the opposite polarity is interfering with the wanted signal.

Two major implications, namely that the carrier-to-noise ratio increases and therefore the bit error rate increases. This will in turn decrease the safety margin of the reception and the system.

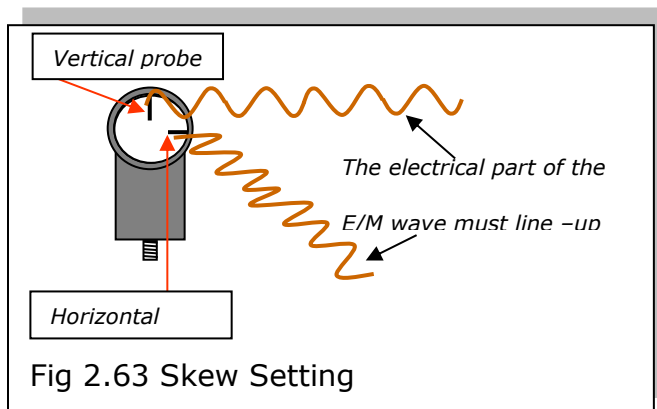

It is important to remember that the probes in the front of the L.N.B. has to be aligned exactly with the electrical part of the electro-magnetic wave (i.e. polarized correctly) to absorb the full amount of signal available.[1]

This implies that the probe will then be totally orthogonal (i.e. at  $90^\circ$ ) to the opposing polarity which means minimum signal pick up from the opposite polarity.

## 2.10.4 The Satellite

### 2.10.5.1 Multichoice Use of Satellites

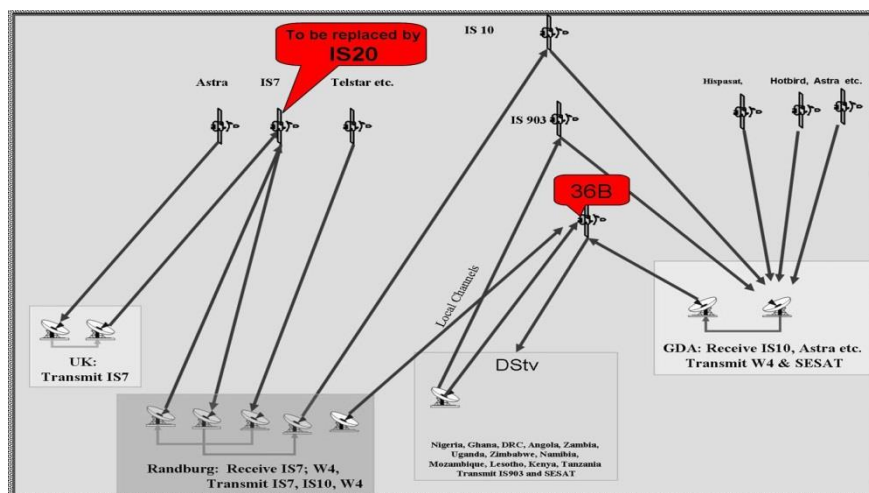

Fig 2.64 Multichoice use of satellites

## 2.10.5.2 Hardware

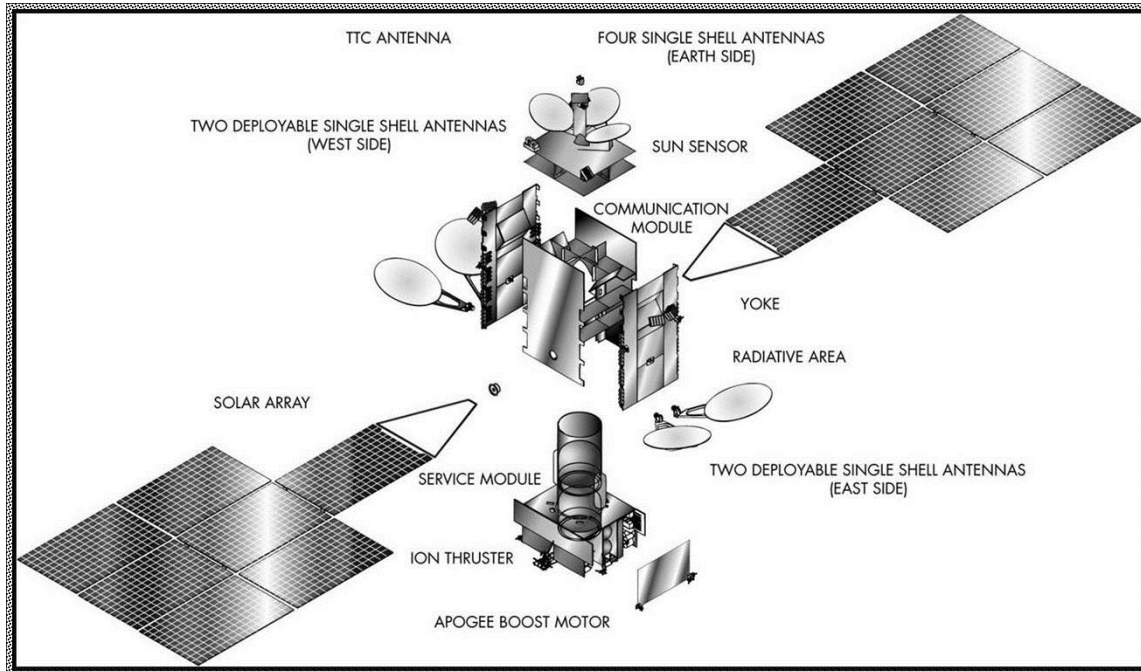

Fig 2.65 Anatomy of a Satellite

## 2.10.5.3 Functions of a Satellite

- To receive the uplink the uplink frequencies from the earth station
- To amplify the received signals
- To down convert the uplink frequencies to downlink frequencies
- To amplify the downlink frequencies
- To switch the incoming signals to the correct downlink antennas

## 2.10.5.4 Structure of the Satellite

### The structural sub-system

This consists of the mechanical structure, shields the satellite from extreme temperature changes and micro-meteorite damage and controls the spin function of the satellite.

### The telemetry sub-system

This sub-system monitors the on-board equipment operation, transmits the information to the earth control station and receives control data from the earth control station.

### The power sub-system

This sub-system consists of the solar panels and the back-up batteries that supply power when the satellite is in the earth's shadow.

### The thermal control sub-system

This sub-system keeps the electronics protected from the extreme difference between the high and low temperatures experienced by the sun side and the shadow side of the satellite.

### The Attitude and Orbit control sub-system

This sub-system consists of small thruster rockets that keep the satellite in its orbital position and keep the antenna pointed in the right direction.[2]

## 2.10.5.5 IS20 Footprint

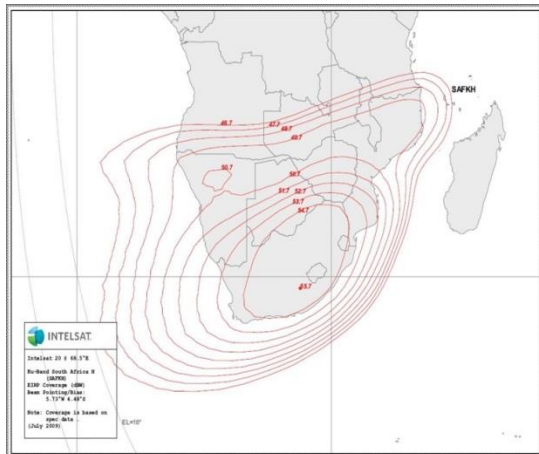

Fig 2.66 (a) dBW coverage (IS20)

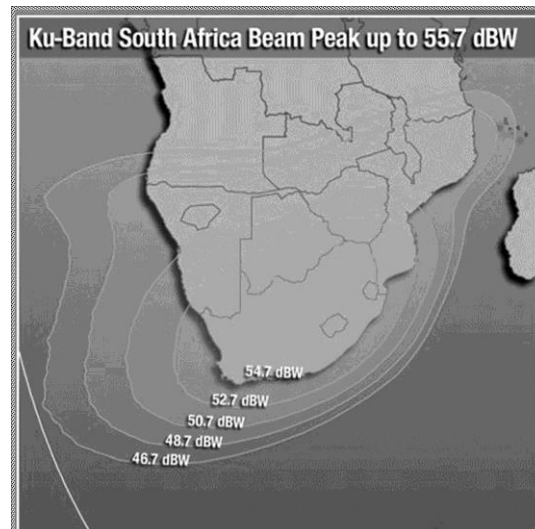
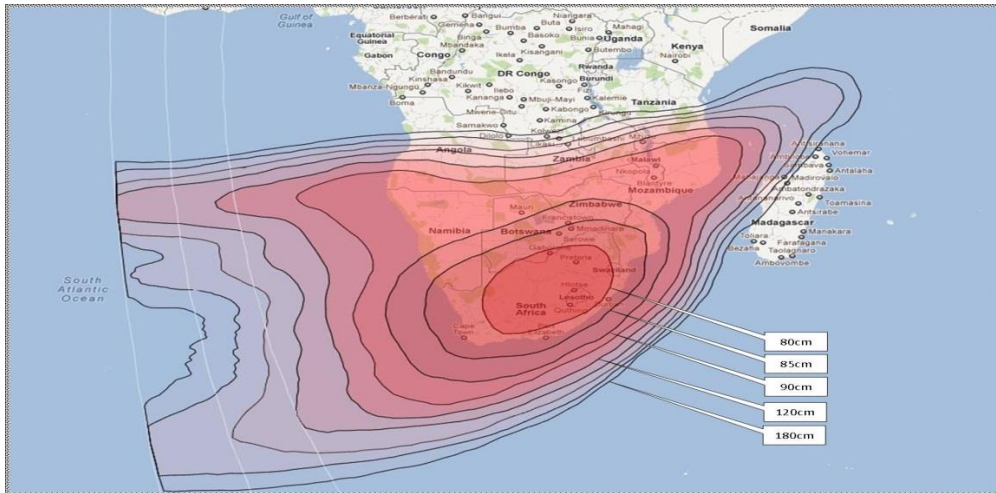
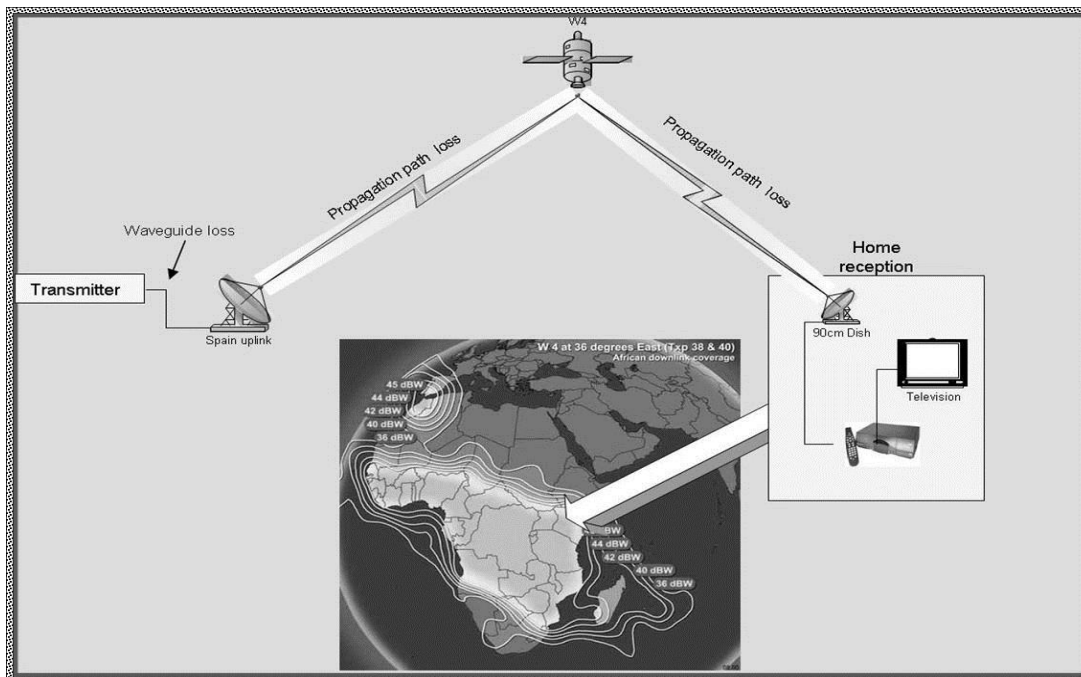

Fig 2.66 (b) Receive power level (IS7)



**Fig 2.66 (c) IS20 Footprint showing coverage by antenna size**

### 2.10.5.6 The Satellite Transmission Path



**Fig 2.67 Satellite Transmission Path**

### 2.10.5.7 What Level of Signal do we receive?

**63100 watts (48dBW –W7)**  
**IS7 is at 55dBW (316200 watts)**  
**48dBW**  
**-152dBW**  
**0.001 pica watt**



A pica watt is a millionth of a millionth of a Watt so we can see that the signal we are receiving at our satellite receive installation is very, very small.)

**NB: CAN WE NOW SEE HOW SMALL THE SIGNAL THAT WE ARE WORKING WITH IS? IT IS VIRTUALLY NOTHING AND WE THEREFORE HAVE TO BE EXTREMELY ACCURATE WITH A DStv INSTALLATION TO ENSURE THAT WE HAVE THE BEST SIGNAL TO WORK WITH. [2]**

## 2.11 Modulation and Transmission Methods

### 2.11.1 Amplitude Modulation

The method of changing the amplitude of the carrier by a modulating signals is referred to as *Amplitude Modulation*. This is type of modulation is used in the present analogue television transmission.

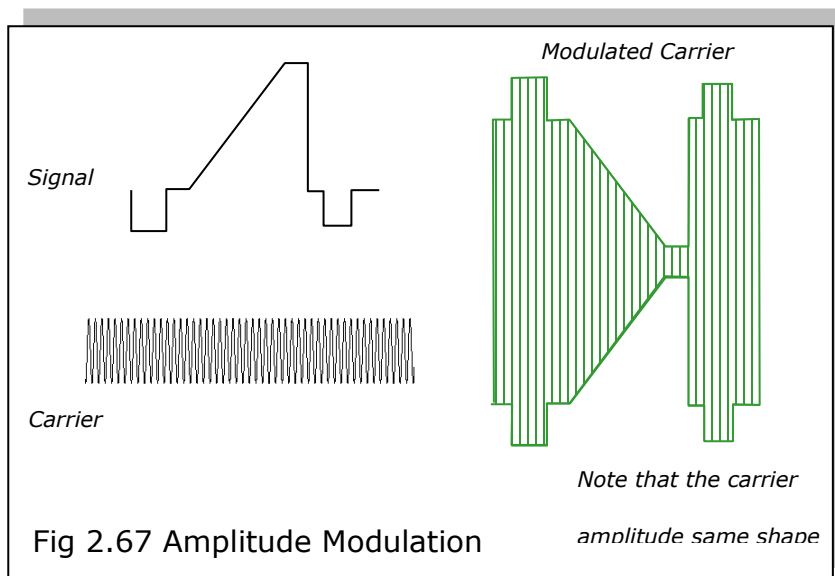

If we refer to figure 2.67 we will notice that the outer shape of the carrier has been changed by the television signal. As this type of wave form is amplitude modulated it is very easily affected by noise and therefore a good signal to noise ratio is required. The bad signal quality is progressive and can be seen as “graininess” in the picture. As this is an analogue signal it will also reveal any type of interference in the picture.

### 2.11.2 Frequency Modulation

The frequency of the carrier wave is changed by the modulating signal and is therefore referred to as frequency modulation. This the type of modulation used for the sound in analogue television.

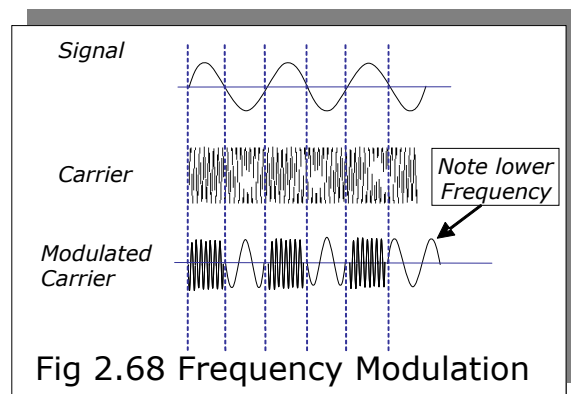

This type of waveform is not easily affected by noise unless the signal level is reduced to a very low level.

### 2.11.3 Quadrature Amplitude Modulation (QAM)

This is the type of modulation used for television in cable systems. It is also used for terrestrial transmission, but due to the difficult transmission path another method is employed as a carrier. The standard is known as DVB-C. There is already thought on improving this standard which

will be DVB-C2, but no protocols have been decided yet. In a cable system this type of modulation is applied directly to the carrier frequencies that presently exist.[2]

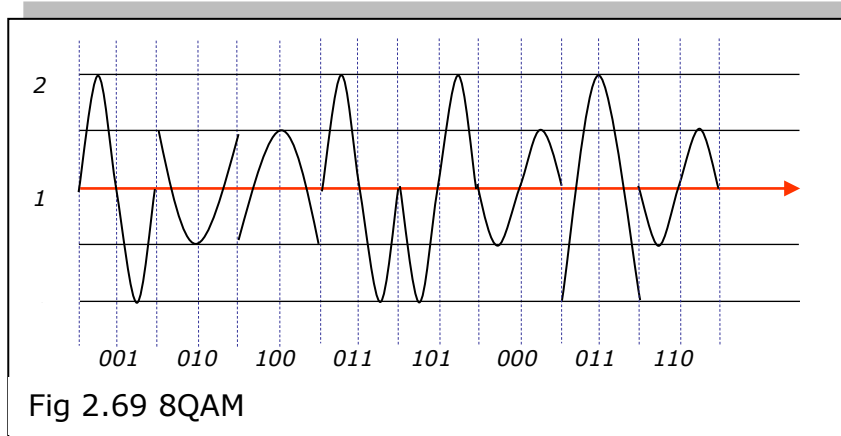

For simplicity the diagram above shows how 8QAM works. Other versions are 16QAM, 64QAM (used in cable systems) and 256QAM (used in fibre optic systems). The method that is used is to have two carriers of the same frequency, but  $90^{\circ}$  out of phase with each other. The carrier has four phase shifts and in conjunction with two different amplitudes as will be seen from the diagram above. By assigning values to these two sets of variables we can have 8 bits of information as the chart below shows.

BIT VALUE	AMPLITUDE	PHASE SHIFT
000	1	$0^{\circ}$
001	2	$0^{\circ}$
010	1	$90^{\circ}$
011	2	$90^{\circ}$
100	1	$180^{\circ}$
101	2	$180^{\circ}$
110	1	$270^{\circ}$
111	2	$270^{\circ}$

This method of modulation can be very susceptible to mismatches and reflections and care must be taken to ensure a quality distribution system is installed to prevent phasing problems.

#### 2.11.4 Quadrature Phased shift Key (QPSK)

This method is mainly used for digital television satellite transmissions. There is no modification of the amplitude of the carrier signal due to the noise considerations and therefore the bandwidth required for the transmission is wider than that of the terrestrial digital transmissions. The standard used is known as DVB-S. Due to the demands for more bandwidth a new standard DVB-S2 is now also in place, especially for the transmission of HDTV programmes.[2]

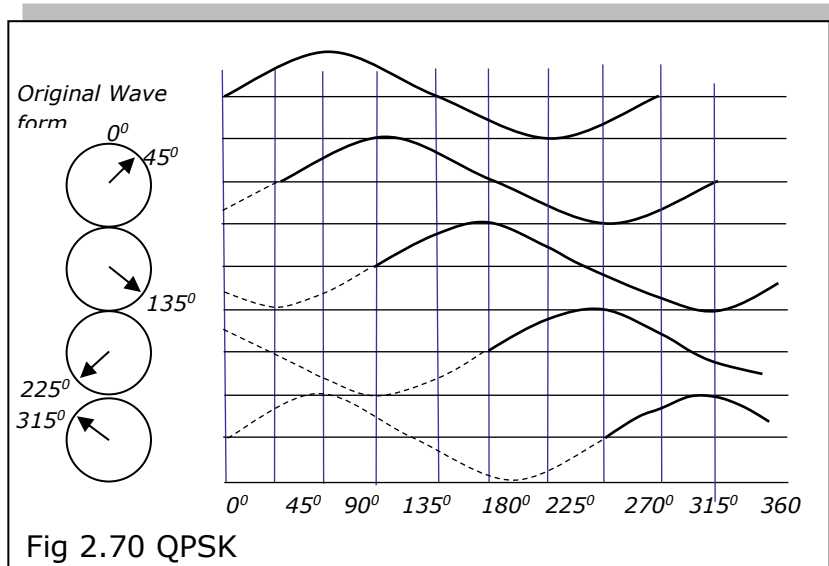

In the diagram above we will notice that the frequency is phase shifted by a quarter ( $90^\circ$ ) for every two bits of information. By using two bits for every phase shift this allows for the use of greater data transfer in a lower band width. In 8PSK four further phase shifts are employed on the waveform to allow for higher data rates to be transmitted.

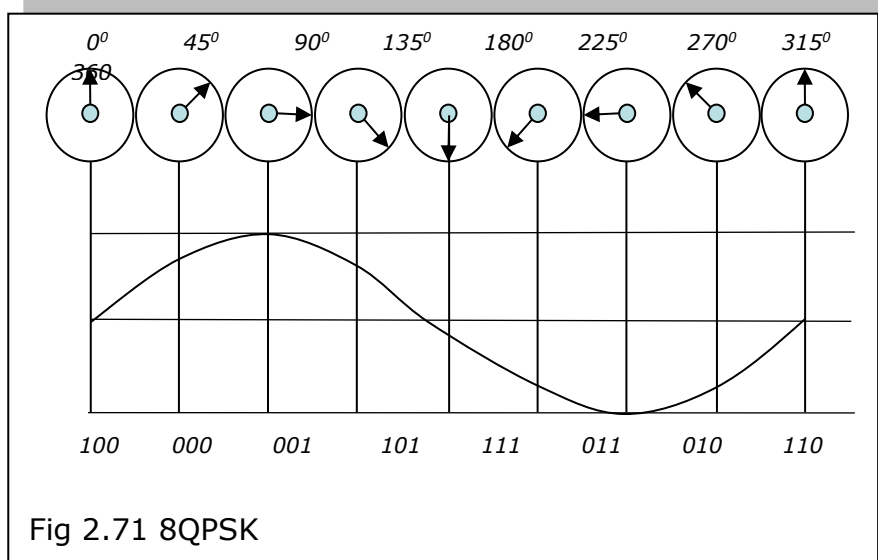

In the diagram above (reduced for simplicity) we will notice that we now employ further phase shifts of  $0^\circ$ ,  $90^\circ$ ,  $180^\circ$  and  $270^\circ$ . This now allows for three (3) bits of data to be transmitted with every phase shift and thus allows for even more data (*30% more*) to be transmitted in a given band width.

### 2.11.5 Coded Orthogonal Frequency Division Multiple (COFDM)

This method is used for the transmission of digital terrestrial signals as the terrestrial transmission is the most difficult medium to use for reliable transmission. This method is presently used for mobile phones. COFDM uses thousands of sub-carriers that don't interfere with each other as they are orthogonal (at right angles- $90^\circ$  out of phase) to each other. The information to be transmitted is distributed interleaved to the many sub-carriers, after the protection coding has been added. Each sub-carrier is vector modulated (Phase shifted). This could be QPSK, 16QAM or 64QAM.

All these frequencies are spaced by a constant interval.

When this group of frequencies is transmitted some will fade due to out-of-phase reflections whilst other frequencies in this group will not and the receiver is then capable of receiving the wanted programmes material. The frequency spacing between the sub-frequencies is determined

by the symbol rate used. In DVB-T the filtering is very sharp which allows for adjacent channel operation and due to the use of GPS for synchronizing the signals the same frequency can be re-used for the distribution of the same group of programmes.

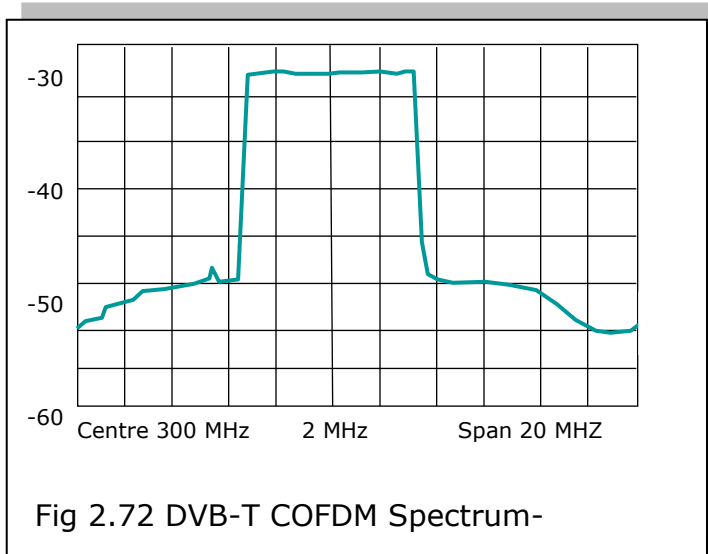

The DVB-T signal is very robust against any reflections and there is talk to use it in cable systems as well.

## 2.12 System Measurements

### 2.12.1 Signal Level

This is an analogue measurement and in television signals will measure the level of the signals at the peak created by the sync pulse. It does not relate to the power contained in the band width carrying the signal.

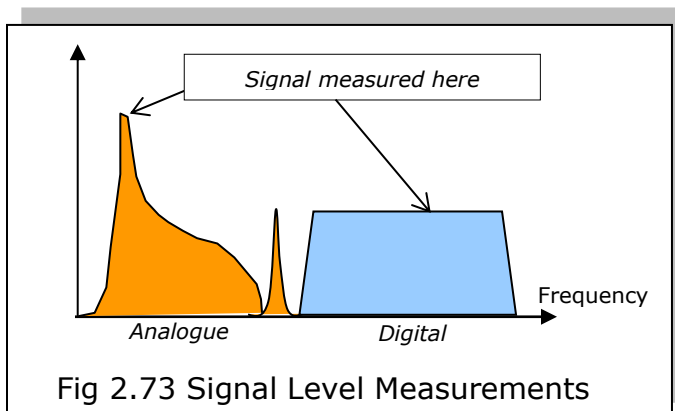

Despite the sentiment that this type of reading must not be used in digital transmission systems, it will still indicate a workable solution as the reading will refer to the level of the digital signal.

**N.B.** This measurement may be used in DVB-S, DVB-C and DVB-T.

### 2.12.2 Digital Carrier Power

This measurement is more suited to digital measurements as it not only takes the level of the signal into account, but also takes the bandwidth of the signal into account. These readings tend to be higher than the signal levels. When doing a comparison between the signal level and DCP on the DStv signals it a difference of 10 to 15 dB is usually measured.

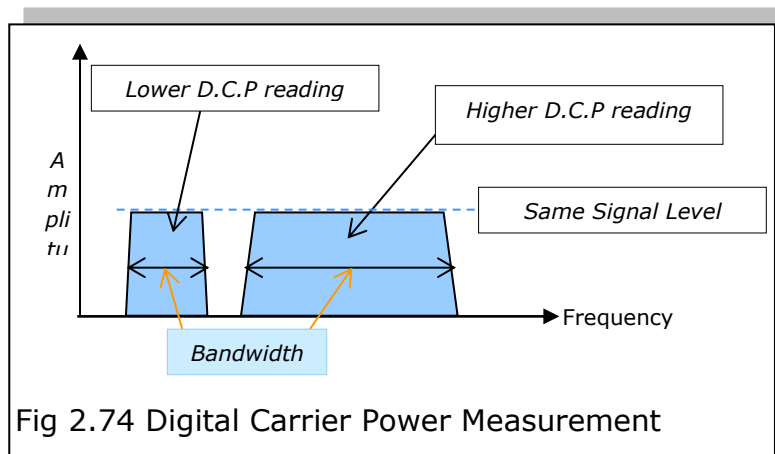

Two signals that have the same signal level reading, but different bandwidths will show two different DCP readings. The wider the bandwidth the higher the DCP reading will be.

### 2.12.3 Bit Error Rate (BER)

This type of measurement is used in both DVB-S, DVB-C and DVB-T. In both systems due to the inner and outer error protection there are three bit error ratios namely;

*Pre-Viterbi BER*

*Pre-Reed-Solomon BER*

*Post-Reed-Solomon BER.*

The most interesting and important reading is the Pre-Viterbi BER as this reading is taken before any error correction takes place and thus provides a good link analysis.

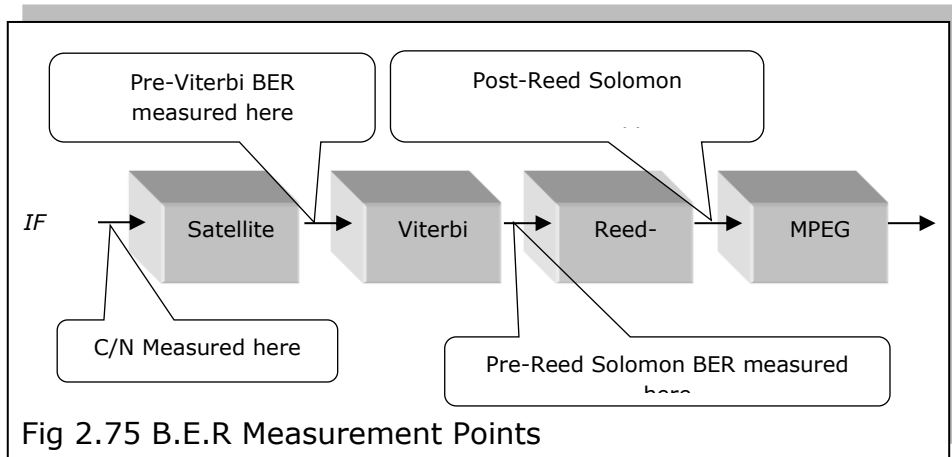

In DVB-C the BER is measured as the Pre-Reed Solomon BER. This is one of the most important measurements as a good BER implies that the cable system installation is technically sound.

Now what exactly is the Bit Error Rate?

This is an indication of the number of error bits that occur in a system as indicated below.

#### BIT ERROR ANALYSIS

1x10 <sup>-1</sup>	1 error bit per 10 bits
1x10 <sup>-2</sup>	1 error bit per 100 bits
1x10 <sup>-3</sup>	1 error bit per 1,000 bits
1x10 <sup>-4</sup>	1 error bit per 10,000 bits
1x10 <sup>-5</sup>	1 error bit per 100,000 bits
1x10 <sup>-6</sup>	1 error bit per 1,000,000 bits
1x10 <sup>-7</sup>	1 error bit per 10,000,000 bits
1x10 <sup>-8</sup>	1 error bit per 100,000,000 bits

The best bit error rate is the one that reads 1x10<sup>-8</sup>.

The bit error rate is closely coupled to the carrier-to-noise ratio



## **CHAPTER 3**

### **TESTING METHODOLOGY**

#### **3.1 Introduction on Testing Methodology**

This chapter will describe in detail the equipment involved in the testing and recording of results, the process of testing and recording the results and the presentation of the results/data. It will look at the three main decoders currently being used by Multichoice, i.e. the 1132, 4U HD decoder, HD PVR decoder, and the Explora decode, the two sizes of the antenna, namely the 60cm and 90cm. It will look at the IS20 satellite to which the Multichoice broadcasts from in Southern Africa. It will look at the equipment being used for measuring the received signal level in this case the DStv Digital Meter.

#### **3.2 Signal Measurements**

##### **Poor installation**

- Signal quality reading of 0%- 59% on either Horizontal or vertical polarity gets a poor installation rating.
- Searching for signal or signal quality of 0% on both horizontal and vertical polarity attracts poor rating.
- Use of dishes 60cm or less attracts an automatic rating of bad installation.

### **Below Average installation**

- Signal quality reading of 60%- 69% on either Horizontal or vertical polarity gets a rating of below average installation

### **Average installation**

- Signal quality reading of 70% to 80% on either Horizontal or vertical polarity gets a rating of above average installation

### **Above average installation**

- Signal quality reading of 80%- 94% on either Horizontal or vertical polarity gets a rating of above average installation

### **Good installation**

- Signal quality reading of between 95%- 100% on both Horizontal or vertical polarity gets a rating of good installation [3]

## **3.3 Test Preparation**

A test site was chosen in Harare randomly. Ease of access was a very important fact in considering the site. The equipment involved in the test was assembled. The site had an already working DStv system installed so it was convenient in terms of providing additional accessories that might be required. The two dishes were measured to confirm their sizes. The measuring meter and all necessary cables were assembled. The following is the list of the equipment used:-

1. 60cm receiving antenna
2. 90cm receiving antenna
3. Universal single LNB
4. Digital Camera
5. DStv Digital measuring meter
6. HDPVR decoder

7. Explora Decoder
8. 4U standard decoder
9. Laptop
10. Cables and connectors
11. Hose for creating rainy weather

### 3.4 Test Setup

Two Poles were stuck to the ground and the two different size antennas were attached to the poles, a 60cm dish and a 90cm dish. A single universal LNB, type triax was used for both dishes. Measurements were done for the two dishes to ascertain the correct measurement of the dishes. A DStv Digital Satellite meter was used to align the dishes with the IS20 Satellite from which the Multichoice broadcasters transmit from. The strength of the signal received is very, very small i.e. 0.001 pica watt. Because the strength of the received signal is very small it is crucial that we have to be extremely accurate to receive a good television signal to work with.



Fig 3.1 Testing setup. Measuring the actual size of the antennas

### 3.5 Testing Process

First to be tested was the 60cm antenna. The antenna was mounted and aligned with IS20 Satellite. Measurements of the received signal were taken and recorded by camera. The signal received was connected to a decoder inside the house to confirm picture presents. The signal level on the television screen as measured by the decoder was also captured by camera. Next to be tested was the 90cm antenna. The process was repeated as was done with 60cm antenna. Results were captured by camera.

As the weather was very clear it was necessary to create some adverse weather conditions. A hosepipe was connected to a water tap and was used to douse the antennas with water to simulate rainfall. It was important to have the water falling on the antenna surface, in front of the dish as well as on the LNB itself. Measurements were taken of the two different size antennas and captured by camera. The signal was also connected to the decoder inside the house to confirm quality of pictured received. The information on the signal status screen of the receiving television was captured by camera. The table showing the recorded results is shown in the next chapter.



Fig 3.2 (a) Using tap water to simulate the effect of rain fade. Fig 3.2 (b) Test Preparations



Fig 4. Received Signal and Quality Level and BER for 90cm antenna

### 3.6 Documentation of Test Results

These results will be documented and a record kept for future reference as well as forwarding to Multichoice Zimbabwe to help them come up with their own policy on the correct size of dish to use. Currently all test on the use of satellite antennas for DStv reception have been down by Multichoice Africa based in South Africa.

### 3.7 Conclusion

Although the whole of Zimbabwe falls under the 85cm footprint coverage of the IS20 Satellite some areas will receive varying signal power levels although not by a bigger margin. It was necessary to carry out test in all the regions of the country in order compare and contrast the results in order to come up with a very accurate decision regarding the use of correct size antennas.

# CHAPTER 4

## DATA PRESENTATION AND ANALYSIS

### 4.1 Introduction

This chapter will present the finding of the project test. Data and results will be presented through the use of pictures, tables, charts and graphs. The findings are also analysed and discussed so as to deduce the meaning of the results.

### 4.2 Results

This section will show the results as they were captured on camera for analyses later in the chapter.

#### 4.2.1 Results for 60cm antenna under clear weather



Fig 4.1 Received signal level and BER respectively for a 60cm antenna under clear weather.

This screen displayed at the end of the satellite and frequency selection operations is the menu that displays the Signal and Quality level and also the deadlock sign. After finding the signal the LOCK sign will appear

#### Signal quality BER indicator

The screen shown in Fig 4.2 above shows the BER which displays the quantity of errors in writing. The lower the BER rate is, the higher the quality and fineness of the broadcast is. Fine tune can be done in LNB using the BER indicator.

### 4.2.2 Results of measurements using 90cm antenna under clear weather

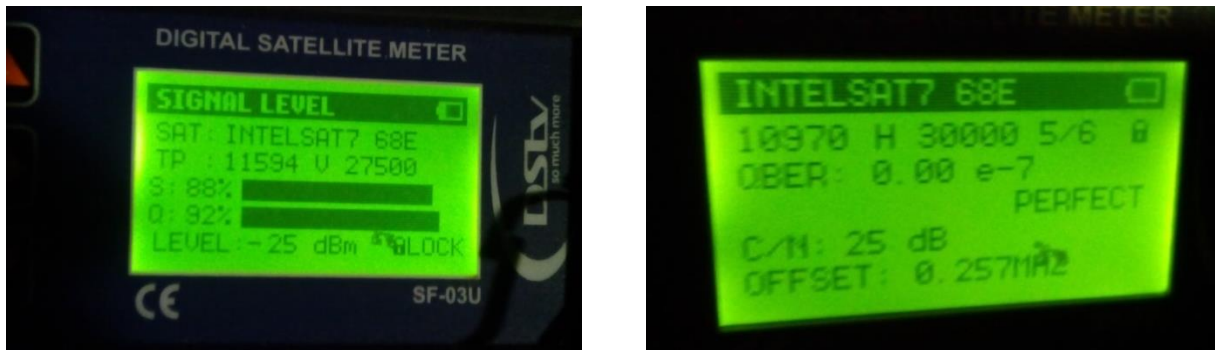

Fig 4.2 Signal quality level BER for 90cm antenna under clear weather

Note the differences in the signal quality under BER screen. The “GOOD” displayed for the 60cm and the “PERFECT” for the 90cm.

### 4.2.3 Results of tests taken for the 60cm antenna under rainy conditions

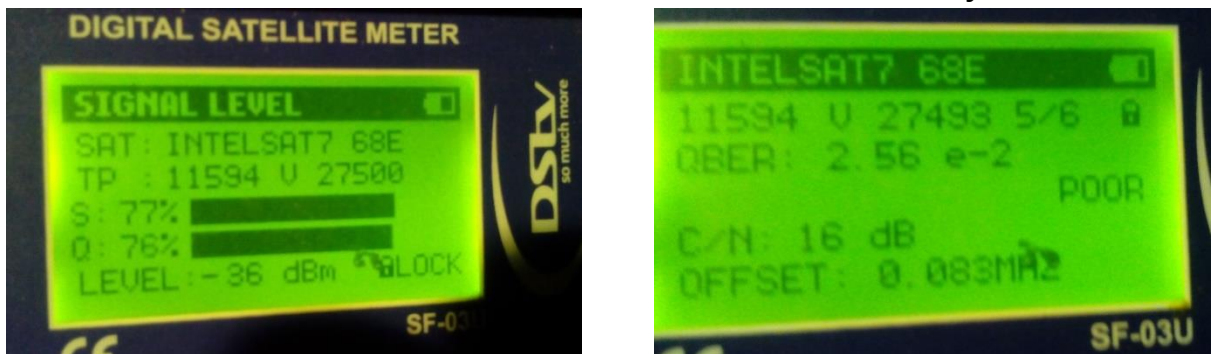

Fig 4.3 Signal level and BER for 60cm antenna under light rain weather conditions

#### 4.2.4 Results for 90cm antenna under clear and rainy conditions



Fig 4.4 Signal quality level and BER for 90cm antenna under light rain conditions

#### 4.2.5 Results on TV display for 60cm and 90cm under light rain conditions

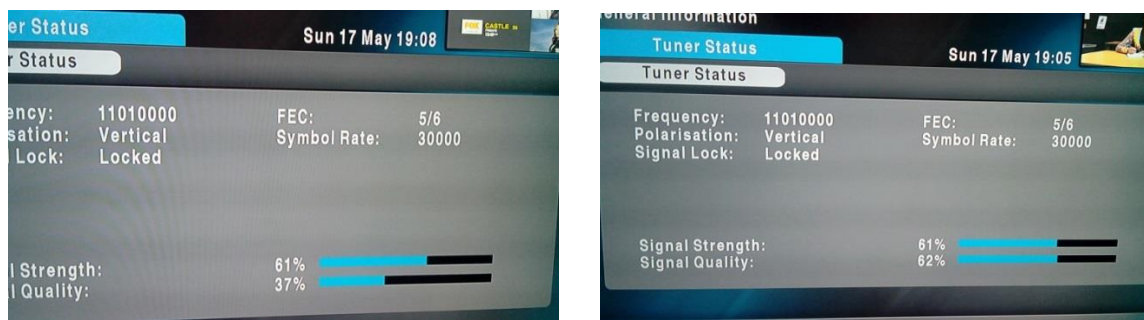

Fig 4.5 TV display for 60cm and 90cm size antenna respectively under light rainy conditions

### 4.3 Data Presentation

Antenna size	Weather Conditions	Signal Quality	BER rate	C/N	Signal Power level	Signal Condition	TV Status	Signal Display
60cm	Clear	78%	e-4	22dB	-26dBm	Good	62%	
90cm	Clear	92%	e-7	25dB	-25dBm	Perfect	87%	
60cm	Light rain	76%	e-2	16dB	-36dBm	Poor	37%	
90cm	Light rainy	84%	e-3	17dB	-30dBm	Good	62%	



#### **4.4 Data Analyses**

From the results displayed it was very clear that there is a difference in strength, quality, power and BER rate for the two different sizes of antenna. There is a marked reduction of signal quality using the 60cm antenna. The BER is higher on the 60cm antenna. When 'rainy' was introduced picture quality was beginning to break up slightly when using the 60cm antenna. When the 90cm antenna was connected under 'rainy' conditions the picture remained perfect despite the slight reduction of signal strength and quality.

#### **4.5 Findings**

The results observed under the 'rainy' conditions give an indication on the effect of rain fade on satellite transmission. The simulation of rain using the hosepipe does not appropriately give all conditions on the ground on a rainy day but was sufficient to record an adverse effect of rain on received signal. Other conditions like overcast sky and lighting were not considered due to the season the test were done.

## **CHAPTER 5**

### **CONCLUSIONS AND RECOMMENDATIONS**

#### **5.1 Summary and conclusion**

Multichoice does not condone the use of 60cm antenna size in Zimbabwe. It is very strict on this matter that Agents or Accredited installers who fail to implement it may be de-registered. The use of 60cm dish is widespread in Zimbabwe. Most of these are brought in by cross-boarder sellers who go and buy them cheap in South Africa. The proper alignment of the antenna plays a major role in the quality of the received signal. The use of appropriate measuring meters cannot be understated. A properly aligned 60cm dish will receive a good signal under clear skies as well as the 90cm antenna. A poorly aligned 90cm dish can have the same effect as a 60cm antenna. The effect of the antenna size is most noticeable when the weather is bad. It is common for antennas under 80cm to start experiencing picture break-ups under adverse weather conditions. It will take very severe weather conditions for a properly aligned 90cm dish to start having picture break-ups. People pay a lot of money to for pay television so it absolutely important to get the alignment right to minimize the loss of picture during bad weather. Decoders measurement circuits are only approximations of the level of strength and quality of the received signal. A display of 80 to 90% on the television screen although giving a fair indication of the received signal level don't give a 100% accurate of the actual power level, signal to noise ratio and BER information. Most of the people tasked with installing these

antennas do not have the proper test meters which give all the information as these meters are very expensive.

## **5.2 Recommendations**

The following recommendations are made:

- It is important for Multichoice to inform customers to insist on a 90cm antenna when purchasing one.
- Installers should educate customers on the merits and demerits on the use of 60cm antenna.
- More tests should be done under different weather conditions as well as in selected parts of the country.



## REFERENCES

- [1] Pierre S. Cronje (2012) DStv Installers Companion Part 2, Johannesburg, RSA
- [2] Marin Ungerer (2014) DStv Installer Manual, Johannesburg, RSA
- [3] [www.multichoice.co.zw/multichoice/view/multichoice/en/page44134](http://www.multichoice.co.zw/multichoice/view/multichoice/en/page44134)